













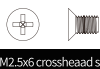



Unpacking

Before using the device, check the device model and ensure that the shipped box includes the following items:

 1x R20K/R20B	 1x Wiring cover	 1x Sealing pressing plate	 1x Rope
 3x Rubber plug (S,M,L)	 6x M2.5x6 crosshead screw	 1x RJ45 coupler ethernet extension connector	 3x RJ45 cable
 20x Name pad (Only for R20B)	 1x Pry bar(Only for R20B)	 3x Diode	 4x Wall-mounting screw

Flush-mounting Accessories:

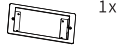
 1x Flush-mounting box	 2x M4x15 torx head screw	 4x ST4x20 crosshead screw	 1x Torx wrench
 4x Plastic wall anchor	 1x Flush-mounting bracket		

Product Overview

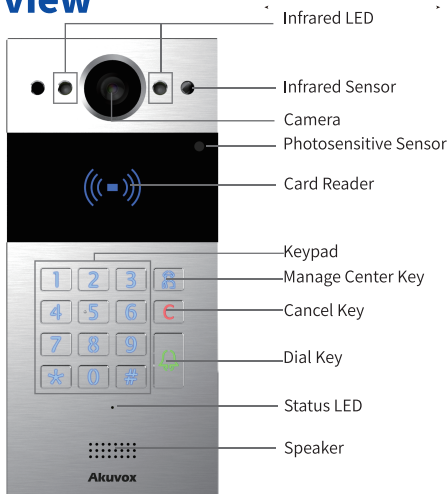

R20K

Before You Start

Tools needed

(not included in shipped box)

- Cat Ethernet Cable
- Crosshead Screwdriver
- Electric Drill

Voltage and Current Specifications

- It is suggested that use PoE or 12VDC 1A power adapter to power on device.

AWG Sizes and Properties Table

Please follow the properly wire data to install device:

Power Supply	12VDC 1A		
AWG	20	22	24
Resistance (ohm/km)	33.9	48.5	79.6
Cross-sectional Area (mm ²)	0.5189	0.3247	0.2047
Wire Length (m)	≤50	≤40	≤20

Requirements

1. Place the device away from sunlight and light sources to prevent potential damage.
2. Do not place the device in the high-temperature, and humid environments or in surroundings impacted by magnetic field.
3. Install the device on the flat surface securely to avoid personal injuries and property loss caused by device's falling.
4. Do not use or place the device near heating objects.
5. If installing the device indoors, please keep device at least 2 meters away from light, and at least 3 meters away from window and door.

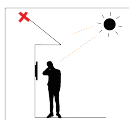

Backlight

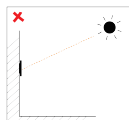

Direct sunlight

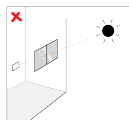

Direct sun through window



Indirect sunlight through window

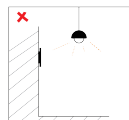

Close to light

Warning!

1. To ensure safety, avoid touching power cord, power adapter, and device with wet hands, bending or pulling the power cord, damaging any components, and use only qualified power adapter and power cord.
2. Be careful that standing up on the area under the device in case of personal injuries cause by hitting the device.

Caution

1. Do not knock device with hard objects.
2. Do not press down hard on the device screen.
3. Do not expose device to chemical products, such as alcohol, acid liquid, disinfectants, and so on.
4. To prevent the device installation from becoming loose, ensure accurate diameters and depths of screw holes. If the screw holes are too large, use glue to secure the screws.
5. Use wet cloth clean device surface softly, and then wipe the surface with dry cloth for cleaning the device.
6. If there is abnormal situation of the device, including uncommon sound and smell, please power off the device and contact Akuvox Technical Team immediately.

Wiring Interface

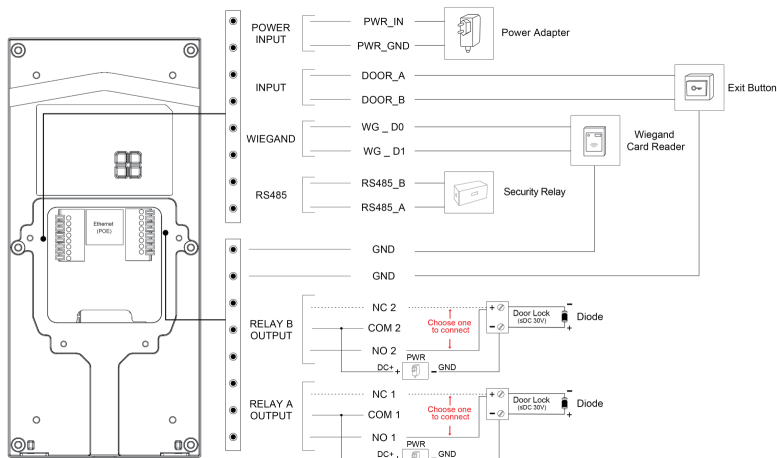

To protect the device from potential damage caused by over-voltage, it is recommended to wire a diode into the circuit. Connect the anode of the diode to the negative cable of the lock, and connect the cathode of the diode to the positive cable of the lock.

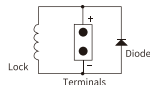

Installation

Step1: Bracket/Box Installation

1. Normal Installation

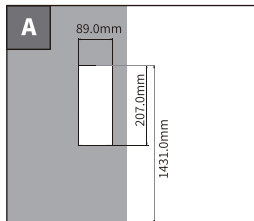

Cut a rectangular hole on the wall (height*wide*depth=207*89*40mm) that can accommodate all the cables.

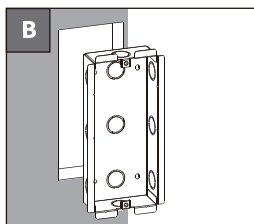

Insert the **flush-mounting box** into the hole.

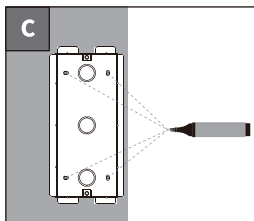

Mark the four holes of the flush-mounting box on the wall.

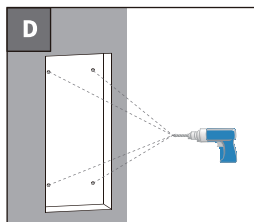

- Remove **flush-mounting box**.
- Use a 6 mm hand drill to make the four holes with a depth of 25 mm.

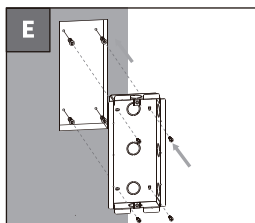

- Insert four **plastic wall anchors** into the holes.
- For fasten the flush-mounting box, tighten the four **ST4x20 crosshead screws** to **plastic wall anchors**.

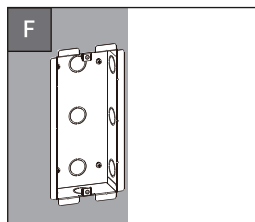

Flush-mounting box installation is completed.

2. Simple Installation (with lower resistance of vandalism)

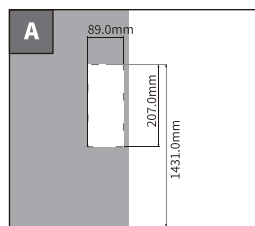

Cut out a square hole on the wall with the dimension 212*286*42mm (height*width*depth).

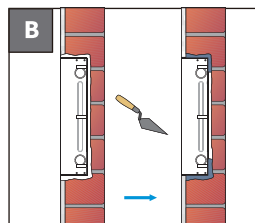

- Use cement or non-corrosive structural adhesive to fill the gap between the wall and flush-mounting box.
- Ensure that the adhesive material dry before proceeding to the next step.

Note: a.To prevent water from entering the back cover of the door phone, it is recommended to fill the gaps around with waterproof material.
b.Or it is recommended to use a rain cover.

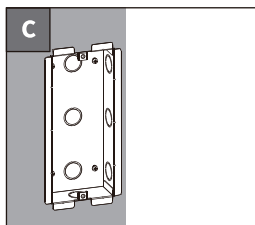

Finish the flush-mounting box installation.

Step2: Flush-mounting Bracket Installation

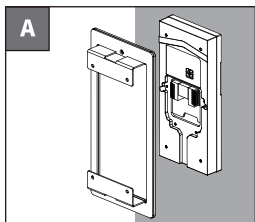

Combine the device with the **flush-mounting bracket** following the orientation indicated in the diagram.

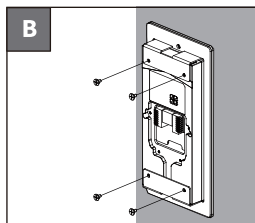

Tighten the device onto the flush-mounting bracket with four **wall-mounting screws**.

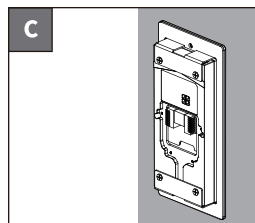

Flush-mounting bracket installation is completed.

Step3: Main Unit Installation

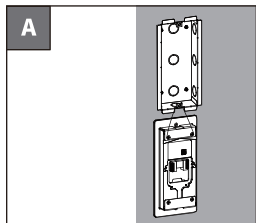

For easier installation, hang the device on the bracket using the **rope**.

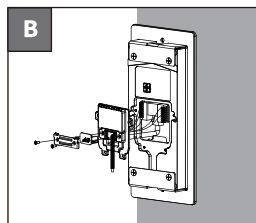

- Make cables go through the **wiring cover**, connecting to the corresponding interfaces as needed (for details, refer to "Wiring Interface").
- Select an appropriate **rubber plug** (small, medium, or large) to secure the wires.
- Fasten **sealing pressing plate** with two **M2.5x6 crosshead screws**.

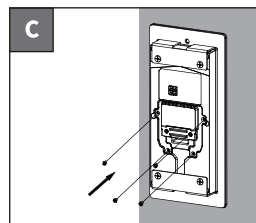

Use four **M2.5x6 crosshead screws** to fix the **wiring cover**.

Step4: Device Mounting

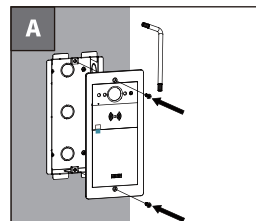

Fix the device on the flush-mounting bracket using two **M4x15 torx head screws**.

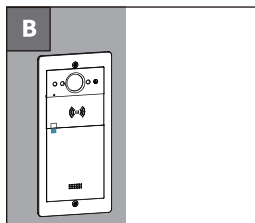

Installation is completed, please remove the protect film.

LED Status Information

LED Status		Description
Blue	Always on	Normal status
	Flashing	Calling
Green	Always on	Talking
	Flashing	Receiving a call
Red	Flashing	Offline

Get Help

For help or more assistance, contact us at:

 <https://ticket.akuvox.com/>

 support@akuvox.com

Scan the QR code to get more videos, guides, and additional product information.



Notice Information

Information contained in this document is believed to be accurate and reliable at the time of printing. This document is subject to change without notice, any update to this document can be viewed on Akuvox' s website: <http://www.akuvox.com> © Copyright 2024 Akuvox Ltd. All rights reserved.