



## DE-X 300 R Polar Trimless In-Wall / In-Ceiling Speaker



### Description

This trimless, high-end, built-in speaker with Polar® technology is designed as a three-way system and features the optimum omnidirectional acoustic dispersion typical of the Polar speaker series. The precise tonal balance and elaborate crossover make the DE-X 300 R Polar the ideal choice for perfect sound reproduction with exceptional low frequency sound.

The DE-X 300 R Polar is comprised of three parts. First, the elegant installation frame is mounted in the ceiling or wall. The speaker unit and the magnetic front grille are then installed. This enables reliable installation and retrofitting, even for complicated installation scenarios.

### Special Features

- Very unobtrusive appearance (only the flush-mounted front grille is visible)
- Small dimensions and installation depth
- 3-way system with Polar® technology
- 180° dispersion
- Perfect sound distribution with a small number of loudspeakers
- 6.5" woofer + 6.5" low-mid woofer + 1" dome tweeter
- 240 watts power capacity
- Very linear frequency response
- High efficiency
- Moisture proof

### Fields of Application

- Home audio
- Conference rooms
- Gastronomy, hotels
- Shops, sales rooms
- Surround systems

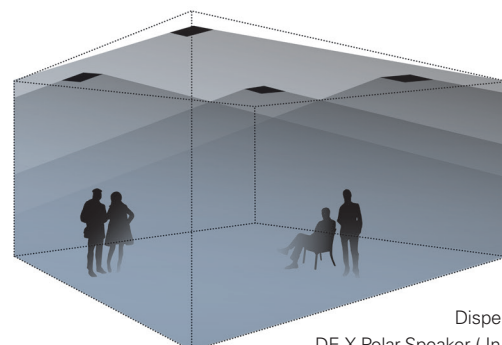

Dispersion characteristic  
DE-X Polar Speaker ( In-ceiling installation)

# DE-X 300 R Polar

## Trimless In-Wall / In-Ceiling Speaker

### Technical Data

Principle	3-way loudspeaker with Polar® technology
Components	6.5" woofer + 6.5" low-mid woofer + 1" dome tweeter
Frequency range	52 Hz – 21 kHz
Impedance	4 ohms
Power capacity	120 watts RMS, 240 watts program
Sensitivity	89 db SPL @ 1 m, half-space (flush-mounted)
Maximum SPL	112 dB @ 1 m
Nominal dispersion	180° (-6 dB bis 5 kHz)
Front grille	Precision steel grille with magnetic fastening, adjustable for flush-mounting
Dimensions front grille	336 × 170 mm
Cutout size	342 × 176 mm
Wall/ceiling thickness	8 ... 30 mm
Material	Precision steel assembly frame and grille, powder-coated
Installation depth	100 mm
Weight	3.8 kg
Connectors	Screw terminals, pluggable
Warranty	5 years

Model	Order No.	Version
DE-X 300 R Polar White	0350-0001	RAL 9016

Other colours and versions on request.



DE-X 300 R Polar without grille

### Dimensions

DE-X 300 R Polar

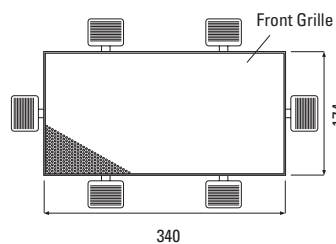

Side View

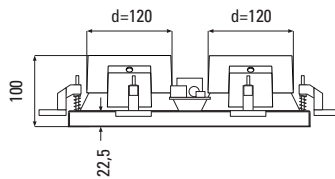

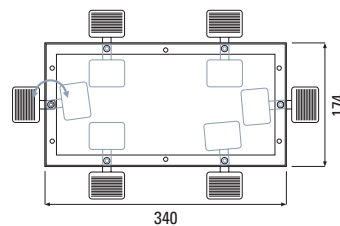

Assembly Frame

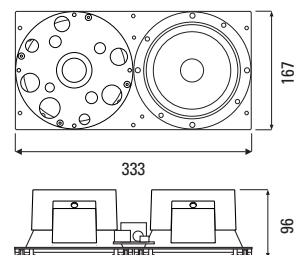

Speaker Unit



## DE-X 300 R Polar Trimless In-Wall / In-Ceiling Speaker

Back Boxes	Order No.	Version
	<b>EG 300</b> 2205-0001	Back box for DE 300 R Polar, DE 300 CDR and DE 300 SUB Plastic, Dim.: 500 × 350 × 140 mm
	<b>EGB 300</b> 2211-0001	Back box for concrete for DE 300 R Polar, DE 300 CDR and DE 300 SUB, Plastic, Dim.: 500 × 350 × 168 mm (incl. rigid foam insert)
	<b>DE-X Tool</b> 0360-0001	Magnetic holder for effortless insertion and removal of front grille

### Dimensions

#### EG 300

Front

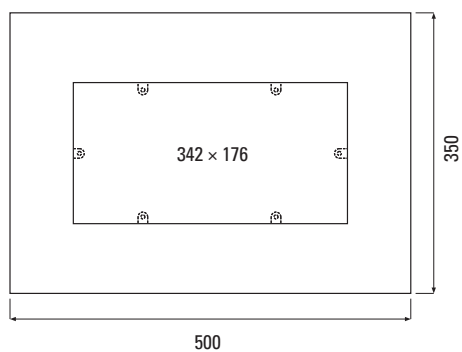

Side



#### EGB 300

Front

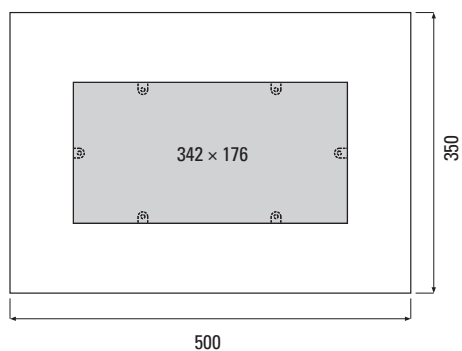

Side

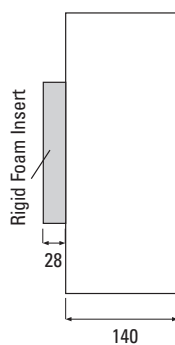

# DE-X 300 R Polar Trimless In-Wall / In-Ceiling Speaker

## Measuring Diagram

DE 300 R Sens. 2,83 V/1m: 89 dB 52 - 20000 Hz (-6 dB) half space

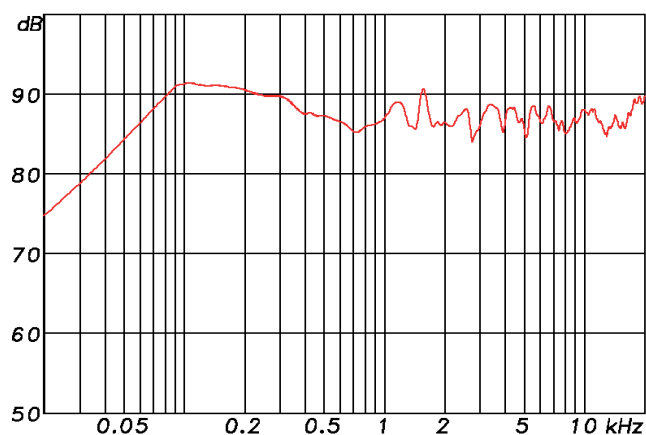

DE 300 R Polar half space Directivity Plot

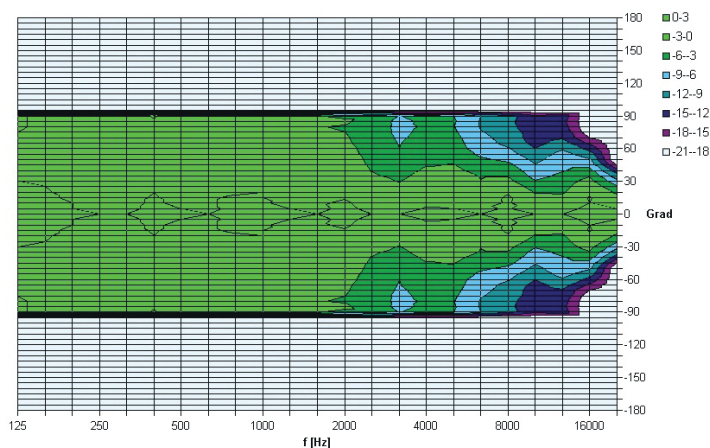

## Assembly (ceiling)

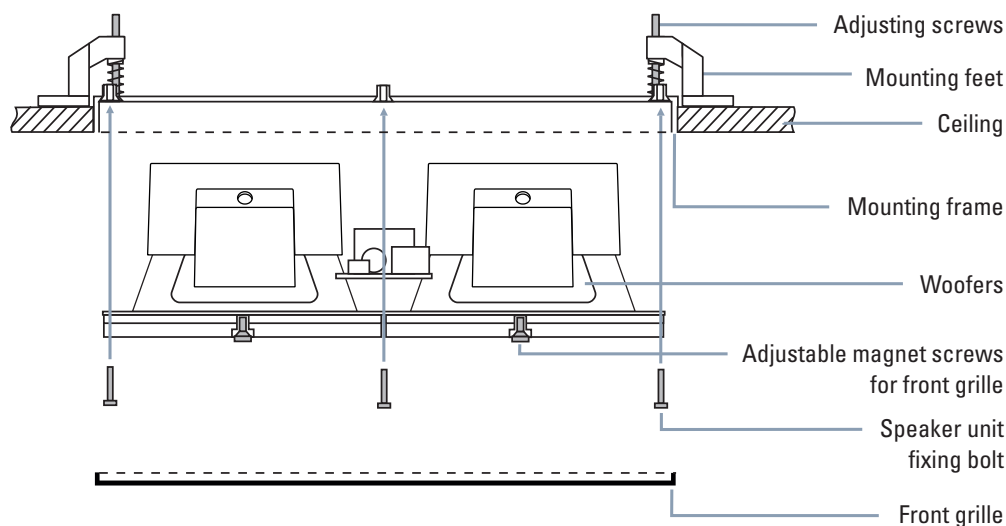

### Installation steps:

1. Slice cut out size in drywall surface (in solid walls / ceilings insert built-in cabinet of the EG series).
2. Insert assembly frame with mounting feet and swivel mounting feet outwards.
3. To fasten, screw the quick-build screws through the wall into the mounting feet.
4. Adjust assembly frame with adjusting screws until flush, plaster and paint.
5. Connect and insert chassis.
6. Insert front grille and, where necessary, readjust the height-adjustable holding magnets.