



PA 2200 DSC 19" Multichannel DSP Amplifier



Description

The PA 2200 DSC is a sophisticated, class-D multi-channel power amplifier with an integrated 8 × 8 DSP matrix and two sockets for different input modules. The three different models in this series are equipped with symmetrical line inputs, asymmetrical cinch inputs or an 8-channel Dante module, and can be expanded by adding a second input module. By combining two input modules, the power amplifier can be operated as a central amplifier unit with a mix of analog and digital signal sources. Ground Lift switch for each input channel pair plus dip switches for modifying input sensitivity on each channel enable the amplifier to be easily adjusted to different signal sources.

The PA 2200 DSC circuits are designed to ensure outstanding sound quality and safety levels with minimum heat build-up. The generously proportioned, high-capacity mains adapter together with our new processor-controlled class-D power amplifier modules guarantee outstanding efficiency levels and enormous power reserves. The Automatic On/Off function (switchable for each channel) automatically switches inactive amplifier channels to an energy-saving Sleep mode. The power amplifier has an output rating of 2 × 200 watts at 2-8 ohms or 1 × 400 watts at 4-16 ohms in bridge mode, the outputs 3-8 are symmetrical line outs.

One or more power amplifiers in the PA DSC series can be connected via Ethernet or USB, programmed using the LB AUDIO CONTROL app on a PC, and operated via a media control system. In addition to the 8 × 8 mixer matrix, the DSP also offers ten fully parametric filters, a delay of up to two seconds, plus compressors and limiters for every input and output. We can also preconfigure project-specific settings on request.

To enable remote control, the amplifiers are equipped with an On/Off contact and VCA inputs with separate channels for external volume control. All outputs can be controlled independently or in groups using our WP-V and RP-V volume controllers or the DV module via Up/Down contacts. Any fault in the power amplifier channels is signaled via the isolated fault contact.

Key Features

- Multichannel amplifier with 8 × 8 DSP-Matrix
- Three models with different Input modules:
 - **PA 2200 DSC** with 8 × line IN symmetrical
 - **PA 2200 DSC CINCH** with 8 × line IN cinch asymmetrical
 - **PA 2200 DSC DANTE** with Dante interface
- 2 × 200 watts / 1 × 400 watts output power at 2 to 8 ohms
- 8 × line IN, 2 × speaker OUT + 6 × line OUT
- Second slot for additional input module
- Interfaces: USB, Ethernet
- VCA inputs per channel
- Switchable Automatic On/Off per channel
- On/Off- and Fault contact
- Switchable Input Sensitivity +4/-6 dBu per channel
- Silent running regulated fans
- Switchable Ground Lift per input channel pair
- 1U chassis, installation depth only 348 mm
- Optional:
 - **8×IN-SYM** input module 8 × line In symmetrical
 - **8×IN-CINCH** input module 8 × line In cinch asymmetrical
 - **DANTE 8×8** 8-channel Dante input module
 - 100 V transformer
 - Volume control (wall-panel WP-V or rack-panel RP-V)
 - DV module for volume control via Up/Down contacts

Fields of Application

- Home audio
- Media rooms
- Conference rooms
- Shops, sales rooms
- Gastronomy
- Clubs, discotheques
- Concert halls, theatres
- Churches

PA 2200 DSC

19" Multichannel DSP Amplifier

Technical Data

Inputs	8 × Line IN sym. / 8 × Line IN cinch asym. / Dante (depending on the model)
Nom. input/output level	+4/-6 dBu, switchable
Max. input/output level	+22 dBu
Input impedance	20 kohms
Load impedance	≥ 2 ohms, Bridge ≥ 4 ohms
Outputs	2 × Speaker OUT up to 2 × 4 mm ² + 6 × line OUT sym. (screwtype terminals, pluggable)
Output power	
2 ohms	2 × 200 watts
4 ohms	2 × 200 watts
8 ohms	2 × 200 watts
Bridge	1 × 400 watts (4 -16 ohms)
Frequency range	15 Hz-22 kHz
Dynamic range	>100 dB
Displays	OLED display, LED for ON/STANDBY; LED for CLIP/LIMIT/DSP/SIGNAL; LEDs per channel for PROTECT, LIMIT, SIGNAL, SLEEP
Controls	Preset selector and power switch at front. Dip switches AUTO ON/STEADY ON and SENSITIVITY +4/-6 dBu per channel at back.
DSP	24 bit, 48 kHz
Latency	0.64 ms
Functions	8 × 8 matrix mixer, 10 parametric filters for each input/output. Filter types: bell, high-shelf, lowshelf, notch, allpass, bandpass, highpass, lowpass. Delay up to 2 sec., limiter and compressor for each input/output, 100 presets
App	LB AUDIO CONTROL download from our website: www.lb-lautsprecher.de/en/Download-Software
Interfaces	Ethernet, USB
Additional connectors	VCA inputs 0-10 V for each channel (also for DV modules), floating Fault contact (N/O), Standby contact (N/O or N/C)
Cooling	Silent running regulated fans, air flow from front to back
Protective circuits	Inrush current limiter, peak limiter, current limiter and power limiter for each speaker output, short circuit and multilevel overtemperature protection for all internal channels
Power supply	230 VAC
Mains connector	IEC connector
Power consumption	
Standby	< 0.5 watts
All channels SLEEP	13 watts
All channels active	19 watts
1/8 th power maximum	78 watts
Max. power consumption	130 watts
Peak power	630 watts
Dimensions (B × H × T)	19", 1U, 483 × 44 × 348 mm
Weight	8 kg
Warranty	5 years

Model

Order No. Versions

PA 2200 DSC	3106-0061	8 × line IN sym. with pluggable screwtype termin
PA 2200 DSC CINCH	3106-0062	8 × line IN cinch asym. with pluggable screwtype terminals
PA 2200 DSC DANTE	3106-0063	Dante interface, 2 × RJ45 Ethernet (primary/secondary)

Accessories – Additional Input Modules

8×IN-SYM	3108-0004	8-channel input module for the PA series/ PA DSC series with symmetrical line inputs. The module features GROUND LIFT dip switches for each channel pair, enabling the amplifiers to be operated with grounded signal sources (internal).
8×IN-CINCH	3108-0008	8-channel input module for the PA series/ PA DSC series with asymmetrical cinch inputs. The module features GROUND LIFT dip switches for each channel pair, enabling the amplifiers to be operated with grounded signal sources (internal).
DANTE 8×8	3108-0009	8-channel Dante input module for the PA series/ PA DSC series. The Dante interface features two RJ45 terminals for audio over Ethernet (primary/secondary). If the primary network connection fails, the module automatically switches to the secondary connection.

Further Accessories

WP-V	3401-0002	Wall panel, volume control for amplifiers of the PA Series for surface boxes. Volume regulation and ON/MUTE via VCA inputs
RP-V	3402-0002	Rack panel, volume control for amplifiers of the PA Series to install in 19" rack mount RP-1U. Volume regulation and ON/MUTE via VCA inputs
RP-1U	3402-0016	19" Rack mount, 1U, for 6 × RP panels
DV-Module	3109-0006	Digital volume control for amplifiers of the PA Series. Volume regulation with dual push buttons (UP/DOWN contacts) via VCA inputs
PA-T 200	3109-0003	100 V transformer module, 200 watts, toroidal core
PA-T 1U	3109-0005	Rack cradle 19", 1U for 4 × PA-T 100, 2 × PA-T 200, 2 × PA-T 400

PA 2200 DSC 19" Multichannel DSP Amplifier

Back View

- | | |
|---|--|
| <ol style="list-style-type: none"> 1 8xIN-SYM Input module 8 x line IN symmetrical 2 8xIN-CINCH Input module 8 x line IN cinch asymmetrical 3 DANTE 8x8 Dante interface, 2 x RJ45 Ethernet 4 ETHERNET RJ45 network connection 7 AUTO ON/STEADY ON dip switch per channel 8 SENSITIVITY dip switch +4/-6 dBu per channel 9 VCA-INPUTS (Voltage Controlled Amplifier) per channel | <ol style="list-style-type: none"> 10 DC OUT 15 V power supply for WP-/RP-V, 60 mA max. 11 FAULT CONTACT N/O 12 EXT. ON/OFF N/C (short circuit plug) 13 Speaker outputs 14 Line outputs 15 IEC mains connection (power cable enclosed) |
|---|--|

PA 2200 DSC

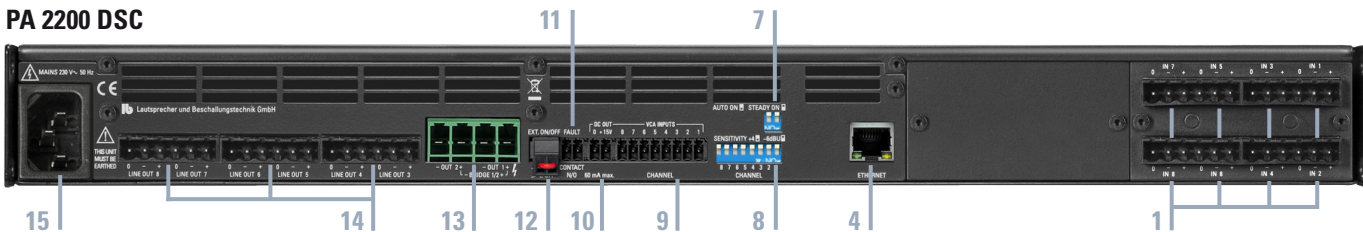

PA 2200 DSC CINCH

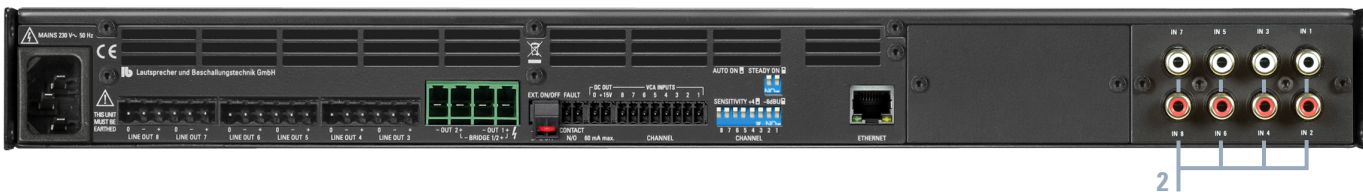

PA 2200 DSC DANTE

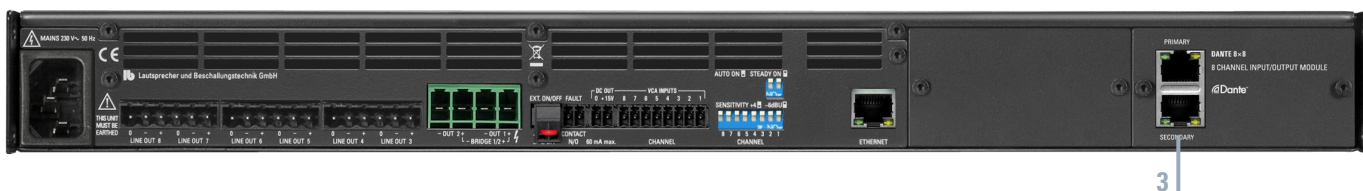

LB AUDIO CONTROL

Browser-based app for controlling and programming LB devices with digital signal processors (DSPs). One or more power amplifiers from the PA-DSC Series can be connected via Ethernet and programmed on the PC using the LB AUDIO CONTROL app and operated via media controls. In addition to the 8 x 8 mixer matrix, the DSP offers ten fully parametric filters, delays of up to 2 seconds as well as compressors and limiters for each input and output. We are happy to create project-related presets upon request.

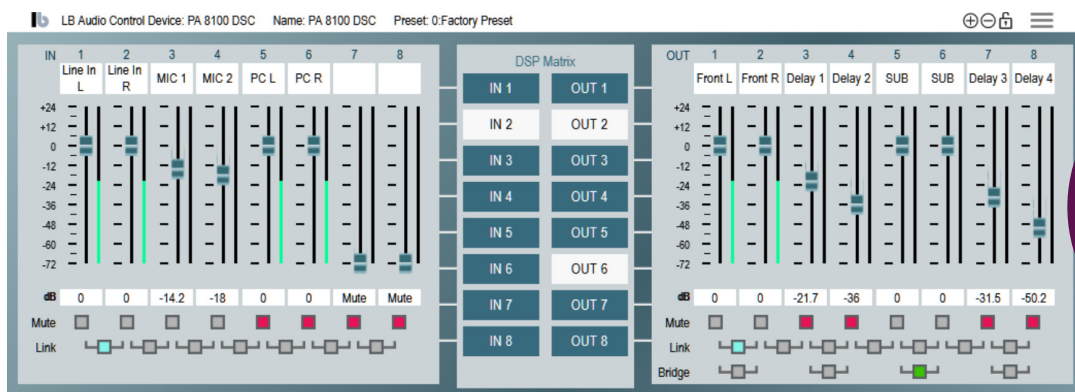

LB AUDIO CONTROL APP

Browser-based Software Interface: Ethernet
Windows + Mac OS

Download:
www.lb-lautsprecher.de



LB AUDIO CONTROL App
Installation Instruction / PDF
More Informationen:

<https://www.lb-lautsprecher.de/sites/default/files/2024-05/LB-AUDIO-CONTROL-Installation-Instruction-2024.pdf>

PA 2200 DSC 19" Multichannel DSP Amplifier

Block diagram PA 2200 DSC

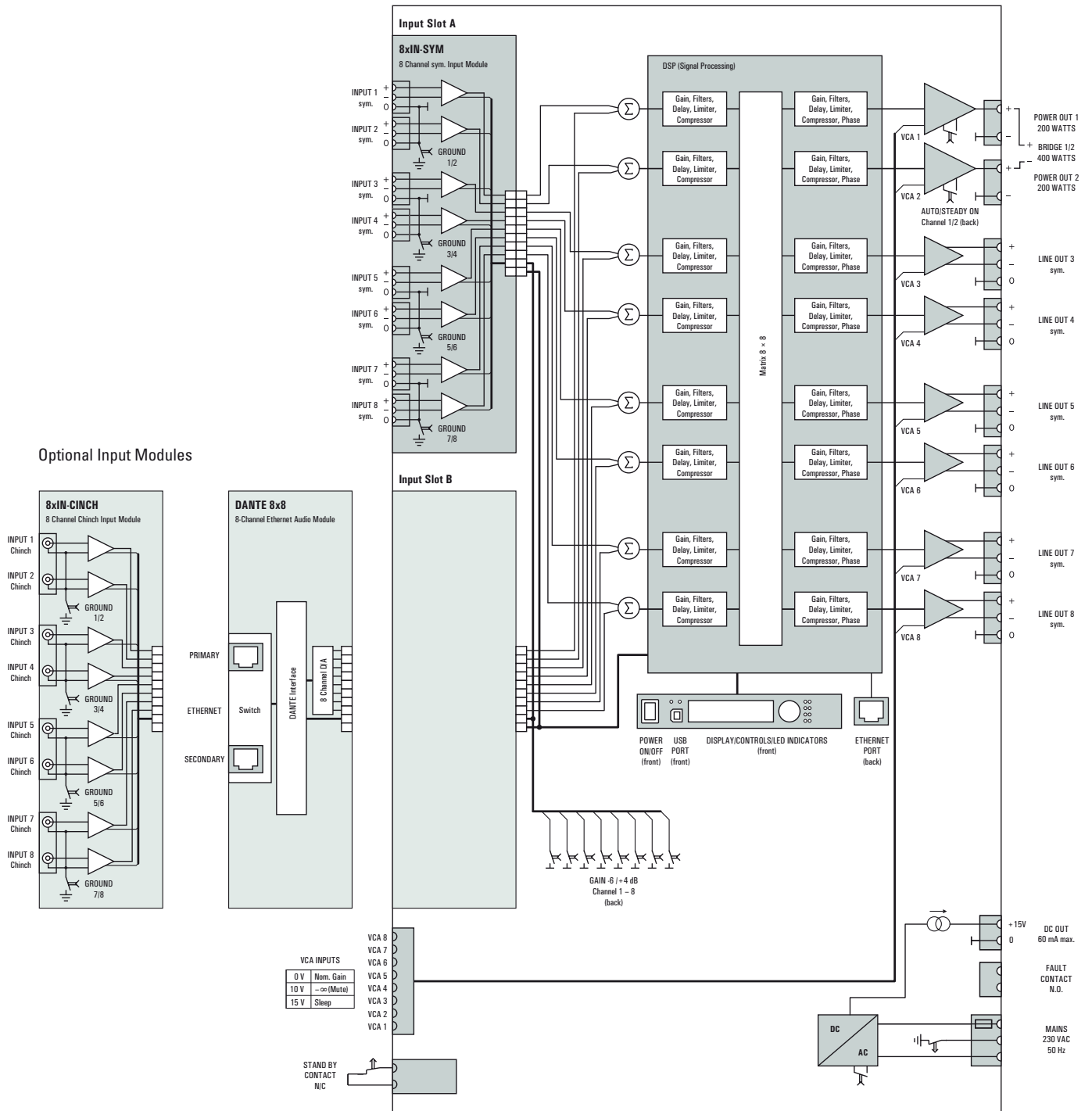

PA 2200 DSC 19" Multichannel DSP Amplifier

Block diagram PA 2200 DSC CINCH

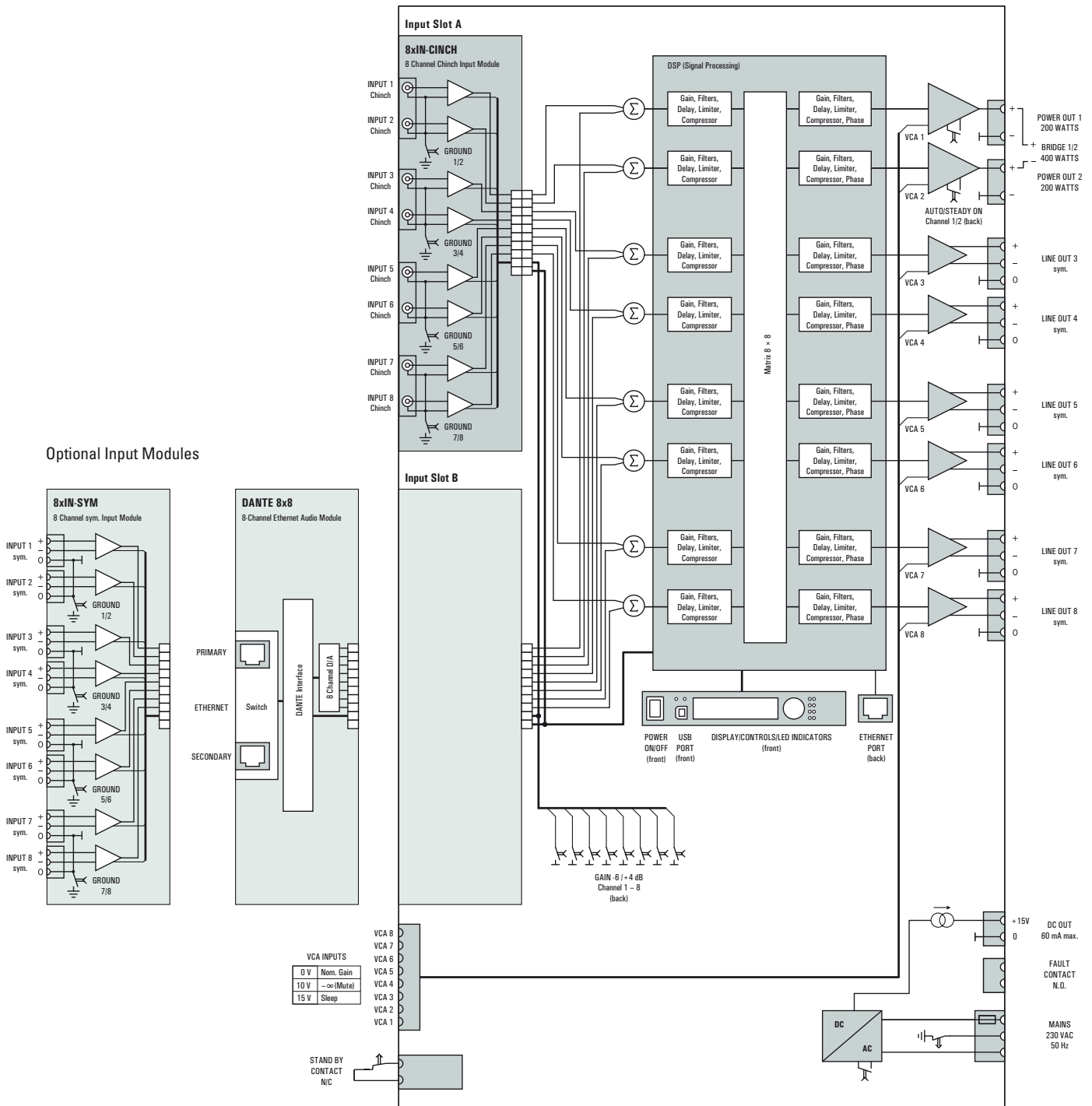

PA 2200 DSC 19" Multichannel DSP Amplifier

Block diagram PA 2200 DSC DANTE

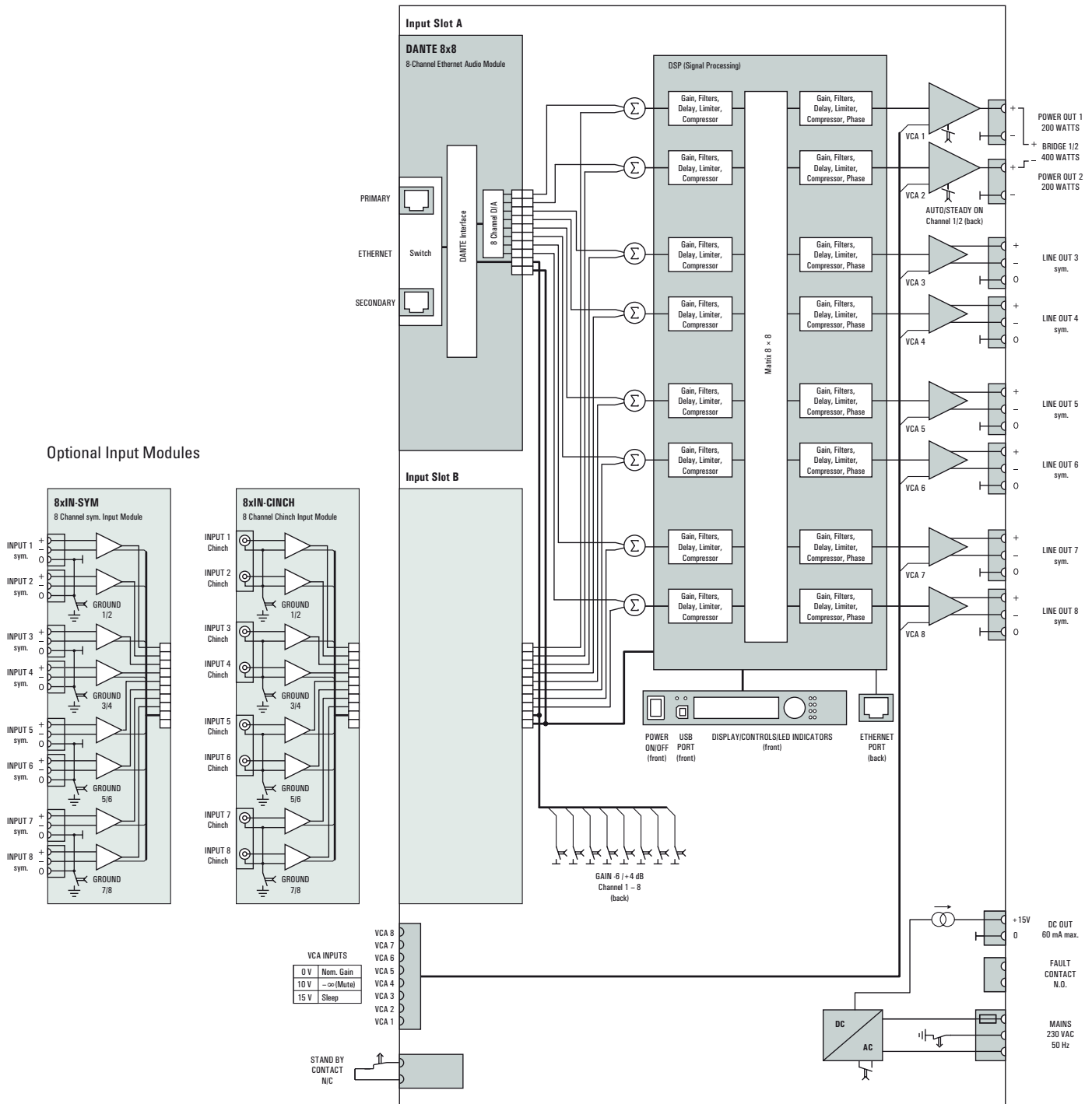

Optional Input Modules

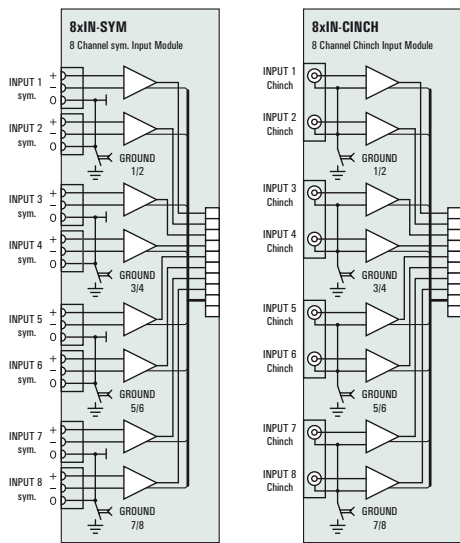

PA 2200 DSC 19" Multichannel DSP Amplifier

Dimensions

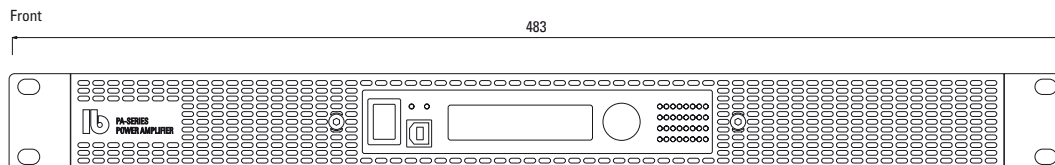

Backsides (examples)

PA 4100/4200/4400 DSC

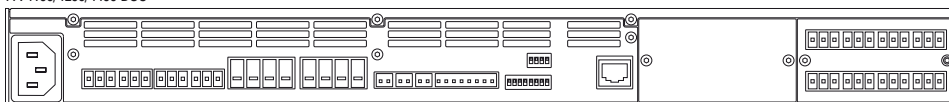

PA 6100/6200 DSC CINCH

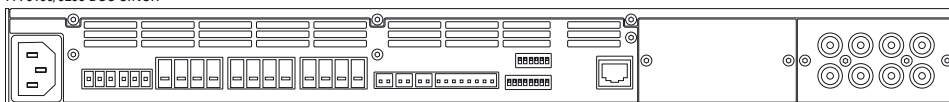

PA 8100/8200 DSC DANTE

