



PA 8800 DSC 19" Multichannel DSP Amplifier

Description

The PA 8800 DSC is a sophisticated, class-D multi-channel power amplifier with an integrated 8 × 8 DSP matrix and two sockets for different input modules. The three different models in this series are equipped with symmetrical line inputs, asymmetrical cinch inputs or an 8-channel Dante module, and can be expanded by adding a second input module. By combining two input modules, the power amplifier can be operated as a central amplifier unit with a mix of analog and digital signal sources. Ground Lift switch for each input channel pair plus dip switches for modifying input sensitivity on each channel enable the amplifier to be easily adjusted to different signal sources.

The PA 8800 DSC circuits are designed to ensure outstanding sound quality and safety levels with minimum heat build-up. The generously proportioned, high-capacity mains adapter together with our new processor-controlled class-D power amplifier modules guarantee outstanding efficiency levels and enormous power reserves. The Automatic On/Off function (switchable for each channel) automatically switches inactive amplifier channels to an energy-saving Sleep mode. The power amplifier has an output rating of 8 × 400 watts at 2-8 ohms or 4 × 800 watts at 4-16 ohms in bridge mode.

One or more power amplifiers in the PA DSC series can be connected via Ethernet or USB, programmed using the LB AUDIO CONTROL app on a PC, and operated via a media control system. In addition to the 8 × 8 mixer matrix, the DSP also offers ten fully parametric filters, a delay of up to two seconds, plus compressors and limiters for every input and output. We can also preconfigure project-specific settings on request.

To enable remote control, the amplifiers are equipped with an On/Off contact and VCA inputs with separate channels for external volume control. All outputs can be controlled independently or in groups using our WP-V and RP-V volume controllers or the DV module via Up/Down contacts. Any fault in the power amplifier channels is signaled via the isolated fault contact.

Key Features

- Multichannel amplifier with 8 × 8 DSP-Matrix
- Three models with different Input modules:
 - **PA 8800 DSC** with 8 × line IN symmetrical
 - **PA 8800 DSC CINCH** with 8 × line IN cinch asymmetrical
 - **PA 8800 DSC DANTE** with Dante interface
- 8 × 800 watts
- 8 × line IN, 8 × speaker OUT
- Second slot for additional input module
- Interfaces: USB, Ethernet
- VCA inputs per channel
- Switchable Automatic On/Off per channel
- On/Off and Fault contact
- Switchable Input Sensitivity +4/-6 dBu per channel
- Silent running regulated fans
- Switchable Ground Lift per input channel pair
- 2 U chassis, installation depth only 348 mm
- Optional:
 - **8×IN-SYM** input module 8 × line In symmetrical
 - **8×IN-CINCH** input module 8 × line In cinch asymmetrical
 - **DANTE 8×8** 8-channel Dante input module
 - 100 V transformer
 - Volume control (wall-panel WP-V or rack-panel RP-V)
 - DV module for volume control via Up/Down contacts

Fields of Application

- Home audio
- Media rooms
- Conference rooms
- Shops, sales rooms
- Gastronomy
- Clubs, discotheques
- Concert halls, theatres
- Churches

PA 8800 DSC

19" Multichannel DSP Amplifier

Technical Data

Inputs	8 × Line IN sym. / 8 × Line IN cinch asym. / Dante (depending on the model)
Nom. input/output level	+4/-6 dBu, switchable
Max. input/output level	+22 dBu
Input impedance	20 kohms
Load impedance	≥ 2 ohms, Bridge ≥ 4 ohms
Outputs	8 × Speaker OUT up to 2 × 4 mm ²
Output power	
2 ohms	8 × 800 watts
4 ohms	8 × 800 watts
8 ohms	8 × 400 watts
Bridge	4 × 1600 watts (4-16 ohms)
Frequency range	15 Hz -22 kHz
Dynamic range	>100 dB
Displays	OLED display, LED for ON/STANDBY; LED for CLIP/LIMIT/DSP/SIGNAL; LEDs per channel for PROTECT, LIMIT, SIGNAL, SLEEP
Controls	Preset selector and power switch at front. Dip switches AUTO ON/STEADY ON and SENSITIVITY +4/-6 dBu per channel at back.
DSP	24 bit, 48 kHz
Latency	0.64 ms
Functions	8 × 8 matrix mixer, 10 parametric filters for each input/output. Filter types: bell, high-shelf, lowshelf, notch, allpass, bandpass, highpass, lowpass. Delay up to 2 sec., limiter and compressor for each input/output, 100 presets
App	LB AUDIO CONTROL download from our website: www.lb-lautsprecher.de/en/Download-Software
Interfaces	Ethernet, USB
Additional connectors	VCA inputs 0-10 V for each channel (also for DV modules), floating Fault contact (N/O), Standby contact (N/O or N/C)
Cooling	Silent running regulated fans, air flow from front to back
Protective circuits	Inrush current limiter, peak limiter, current limiter and power limiter for each speaker output, short circuit and multilevel overtemperature protection for all internal channels
Power supply	230 VAC
Mains connector	IEC connector
Power consumption	
Standby	< 0.5 watts
All channels SLEEP	26 watts
All channels active	172 watts
1/8 th power maximum	1033 watts
Max. power consumption	1450 watts
Peak power	9700 watts
Dimensions (B × H × T)	19", 2U, 483 × 88 × 348 mm
Weight	15 kg
Warranty	5 years

Model

Order No. Versions

PA 8800 DSC	3106-0094	8 × line IN sym. with pluggable screwtype terminals
PA 8800 DSC CINCH	3106-0095	8 × line IN cinch asym. with pluggable screwtype terminals
PA 8800 DSC DANTE	3106-0096	Dante interface, 2 × RJ45 Ethernet (primary/secondary)

Accessories – Additional Input Modules

8×IN-SYM 3108-0004



8-channel input module for the PA series/ PA DSC series with symmetrical line inputs. The module features GROUND LIFT dip switches for each channel pair, enabling the amplifiers to be operated with grounded signal sources (internal).

8×IN-CINCH 3108-0008



8-channel input module for the PA series/ PA DSC series with asymmetrical cinch inputs. The module features GROUND LIFT dip switches for each channel pair, enabling the amplifiers to be operated with grounded signal sources (internal).

DANTE 8×8 3108-0009



8-channel Dante input module for the PA series/ PA DSC series. The Dante interface features two RJ45 terminals for audio over Ethernet (primary/secondary). If the primary network connection fails, the module automatically switches to the secondary connection.

Further Accessories

WP-V 3401-0002



Wall panel, volume control for amplifiers of the PA Series for surface boxes. Volume regulation and ON/MUTE via VCA inputs

RP-V 3402-0002



Rack panel, volume control for amplifiers of the PA Series to install in 19" rack mount RP-1U. Volume regulation and ON/MUTE via VCA inputs

RP-1U 3402-0016



19" Rack mount, 1U, for 6 × RP panels

DV-Module 3109-0006



Digital volume control for amplifiers of the PA Series. Volume regulation with dual push buttons (UP/DOWN contacts) via VCA inputs

PA-T 800 3109-0007



100 V transformer module, 800 watts, toroidal core

PA-T 2U 3109-0008



Rack cradle 19", 2U for 2 × PA-T 800

PA 8800 DSC 19" Multichannel DSP Amplifier

Back View

- | | |
|---|--|
| <ul style="list-style-type: none"> 1 8xIN-SYM Input module 8 x line IN symmetrical 2 8xIN-CINCH Input module 8 x line IN cinch asymmetrical 3 DANTE 8x8 Dante interface, 2 x RJ45 Ethernet 4 ETHERNET RJ45 network connection 7 AUTO ON/STEADY ON dip switch per channel 8 SENSITIVITY dip switch +4/-6 dBU per channel | <ul style="list-style-type: none"> 9 VCA-INPUTS (Voltage Controlled Amplifier) per channel 10 DC OUT 15 V power supply for WP-/V/RP-/V, 60mA max. 11 FAULT CONTACT N/O 12 EXT. ON/OFF N/C (short circuit plug) 13 Speaker outputs 15 IEC mains connection (power cable enclosed) |
|---|--|

PA 8800 DSC

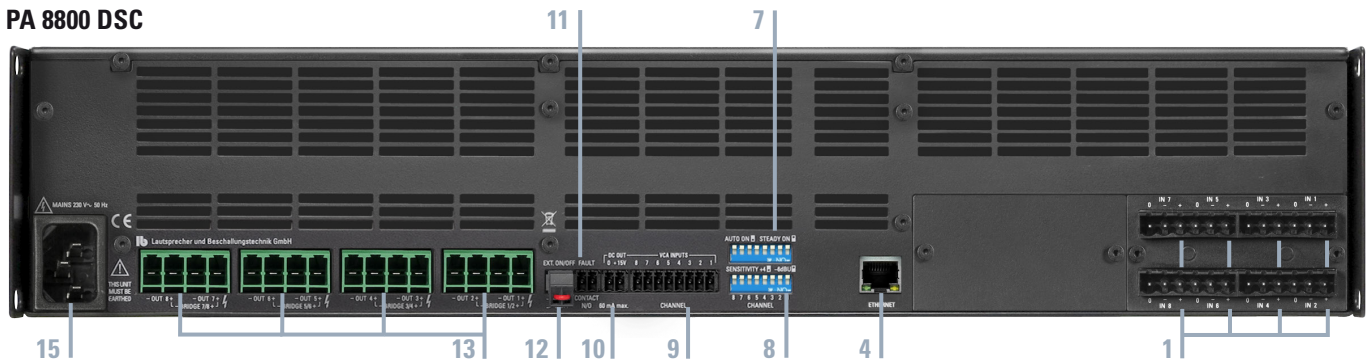

PA 8800 DSC CINCH

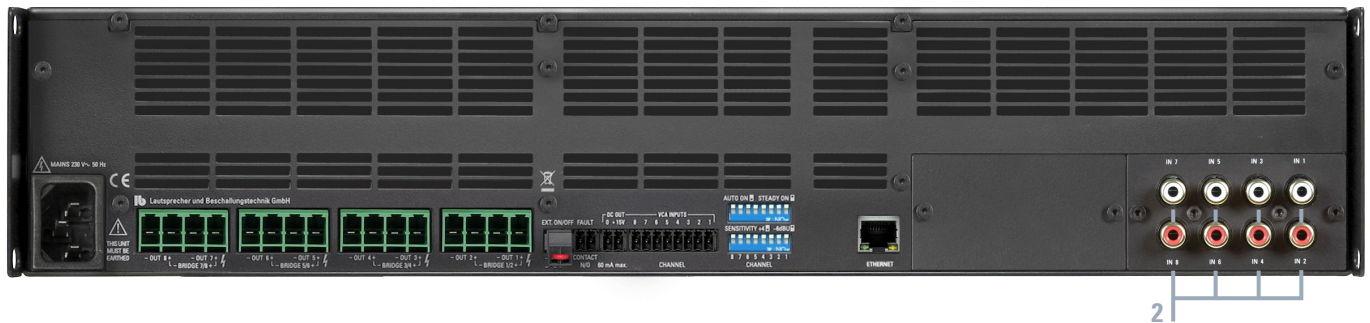

PA 8800 DSC DANTE

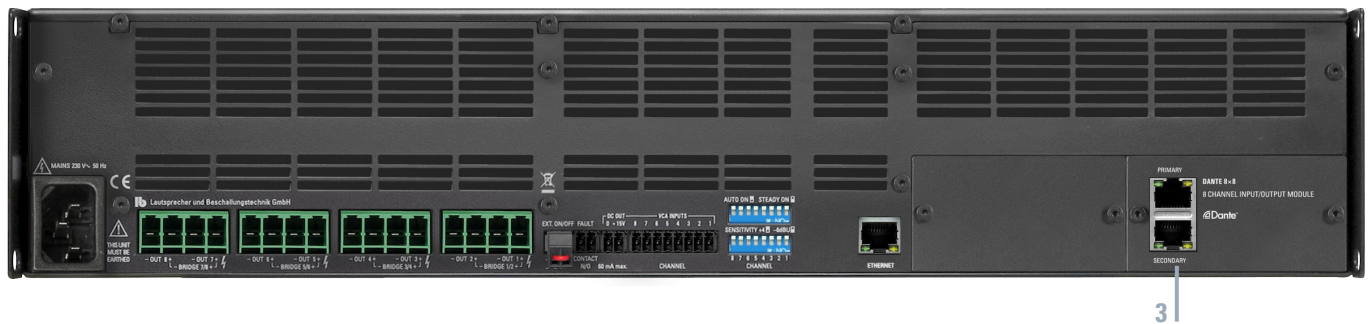

PA 8800 DSC 19" Multichannel DSP Amplifier

LB AUDIO CONTROL

Browser-based app for controlling and programming LB devices with digital signal processors (DSPs). One or more power amplifiers from the PA-DSC Series can be connected via Ethernet and programmed on the PC using the LB AUDIO CONTROL app and operated via media controls. In addition to the 8 × 8 mixer matrix, the DSP offers ten fully parametric filters, delays of up to 2 seconds as well as compressors and limiters for each input and output. We are happy to create project-related presets upon request.

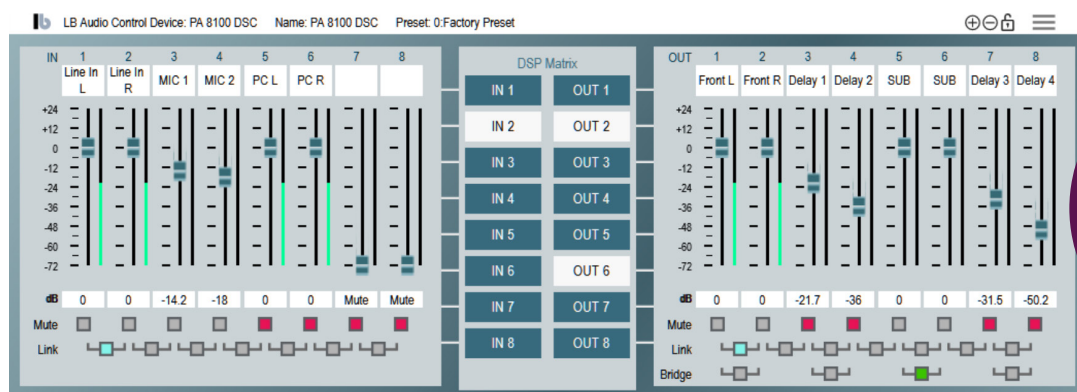

LB AUDIO CONTROL APP

Browser-based Software Interface: Ethernet
Windows + Mac OS

Download:
www.lb-lautsprecher.de



LB AUDIO CONTROL App
Installation Instruction / PDF
More Informationen:

<https://www.lb-lautsprecher.de/sites/default/files/2024-05/LB-AUDIO-CONTROL-Installation-Instruction-2024.pdf>

PA 8800 DSC 19" Multichannel DSP Amplifier

Block diagram PA 8800 DSC

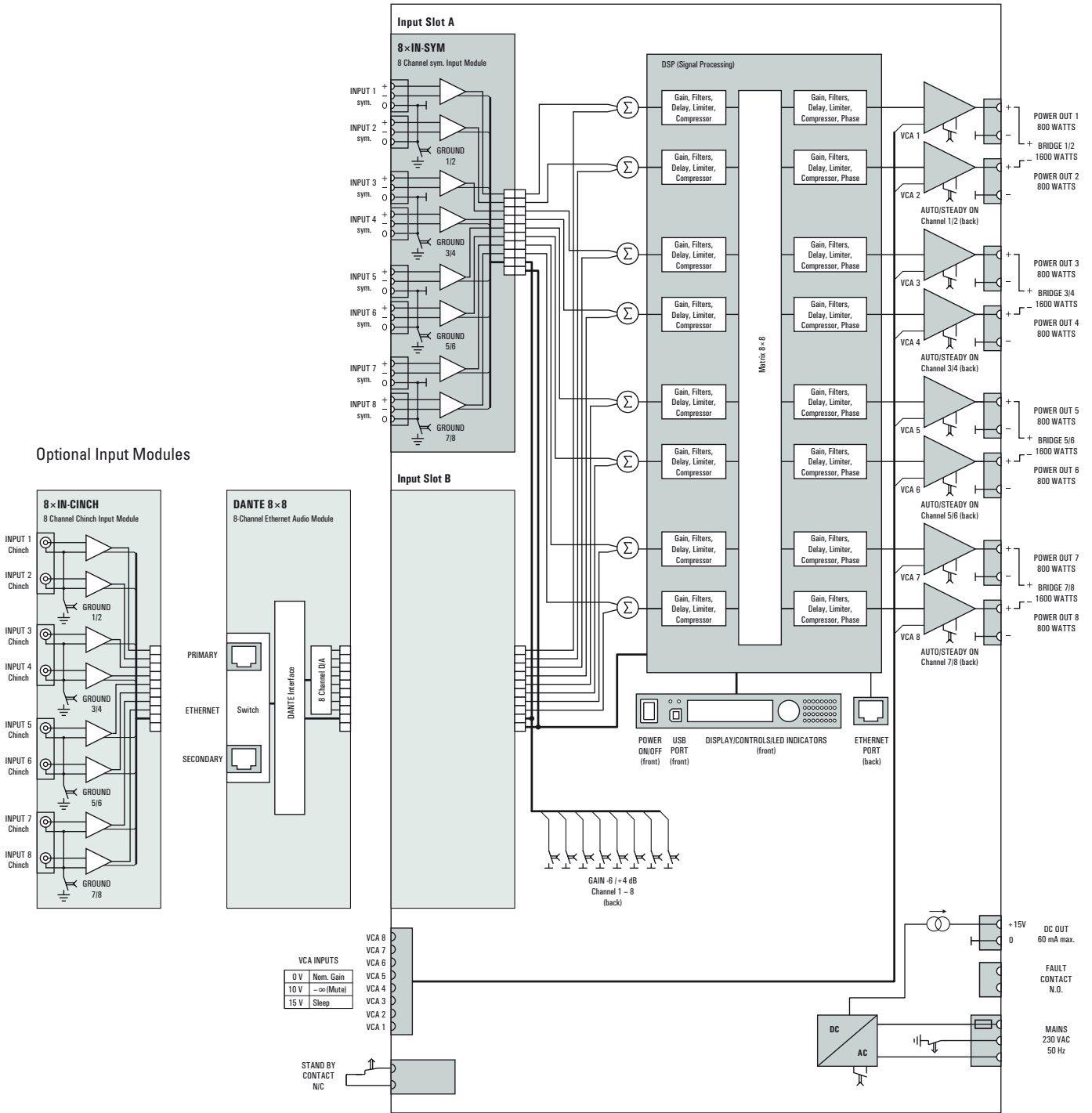

PA 8800 DSC 19" Multichannel DSP Amplifier

Block diagram PA 8800 DSC CINCH

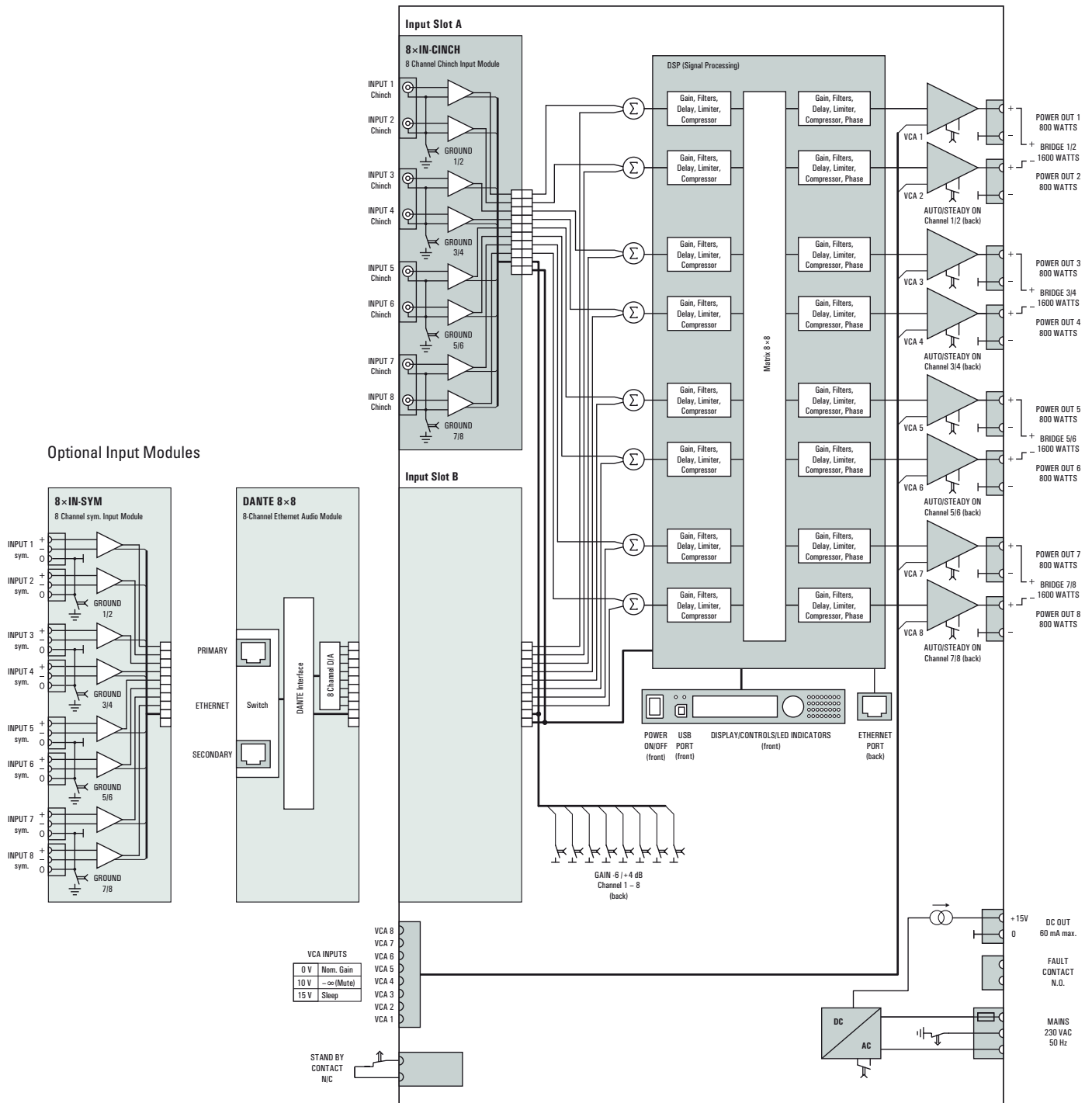

PA 8800 DSC 19" Multichannel DSP Amplifier

Block diagram PA 8800 DSC DANTE

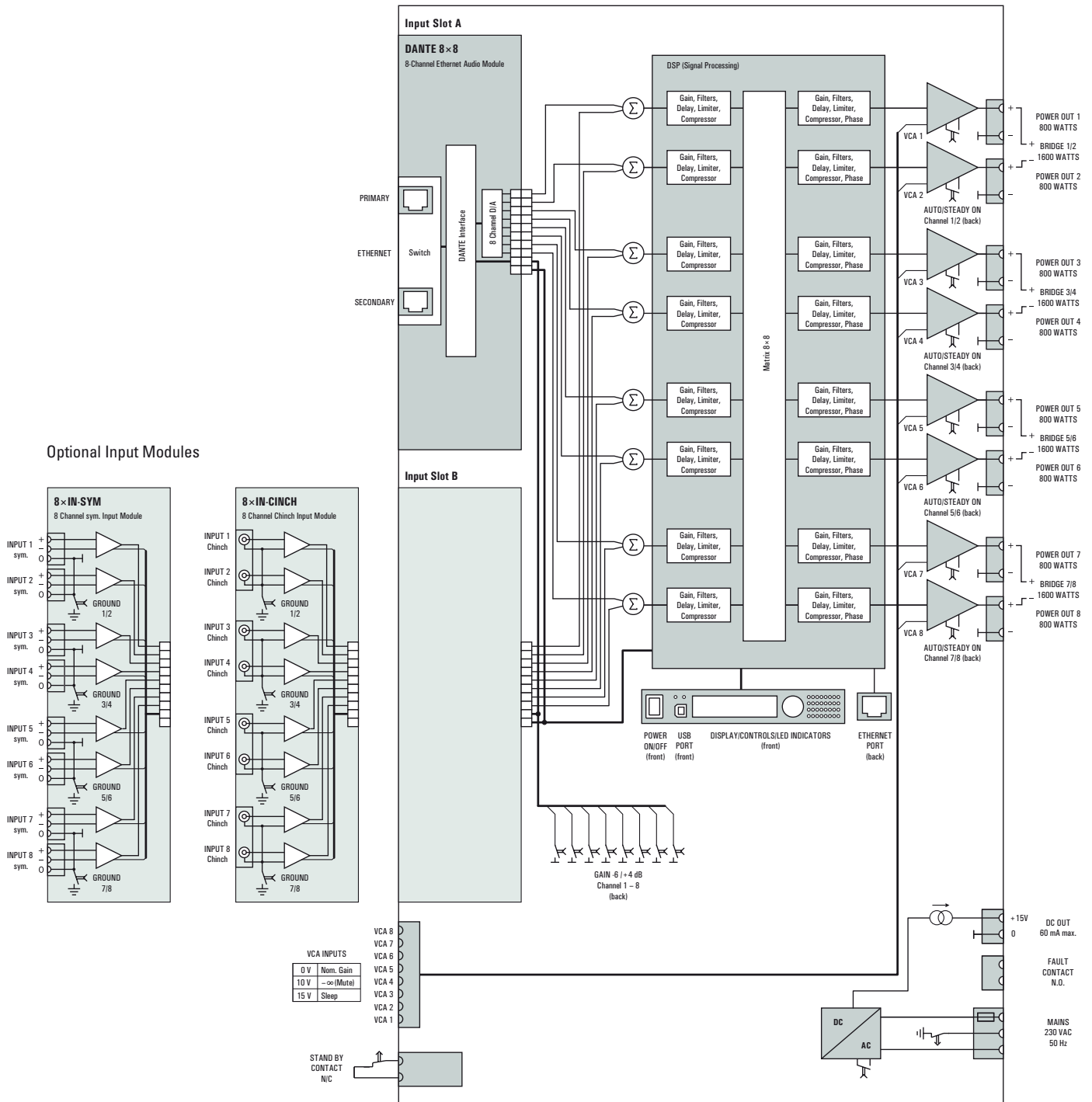

Optional Input Modules

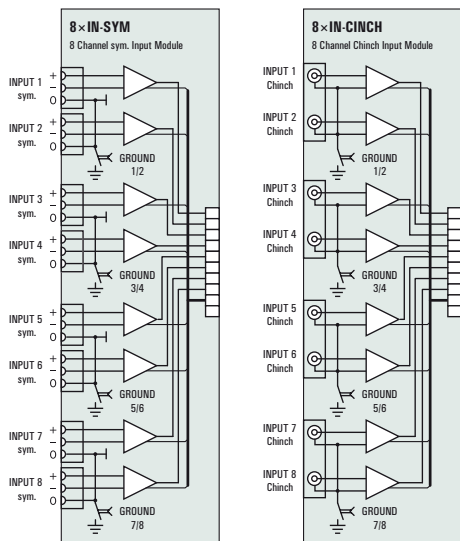

PA 8800 DSC 19" Multichannel DSP Amplifier

Dimensions

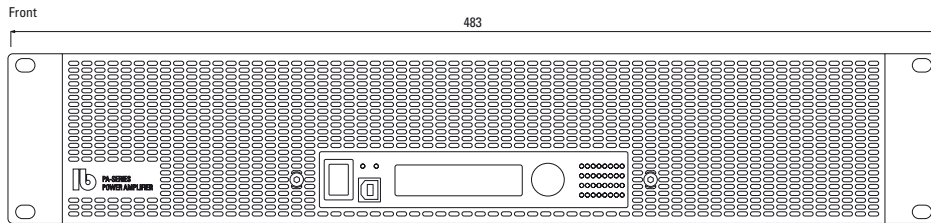

Backsides (examples)

PA 6400 DSC

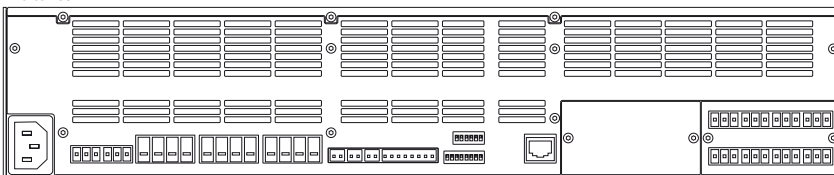

PA 6400 DSC CINCH

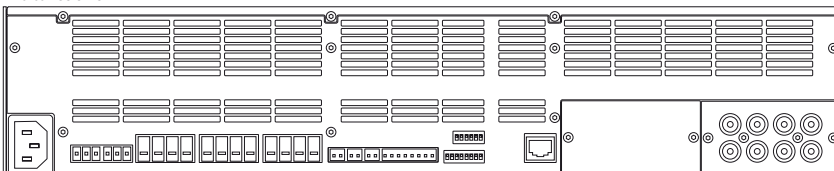

PA 8400 DSC DANTE

