



SB-A 2.0 DCS / SB-A 2.0 DCS DANTE Active Stereo Soundbar with Integrated DSP

DIS
play
series

Description

Active stereo soundbar with a highly linear frequency response, clear speech reproduction for mounting in displays and video walls. The SB-A 2.0 DCS soundbar is designed for video conferences and high-quality sound reproduction in conference and media rooms. It can be configured with our LB CONTROL App and controlled and monitored via network commands. The standard version is equipped with analog inputs and an optical SPDIF input (Toslink), the SB-A 2.0 DCS DANTE version also has a DANTE interface. A powerful digital signal processor (DSP) with multi-band limiters and a wide range of setting options ensures excellent music reproduction and at the same time precise speech reproduction with high intelligibility and headroom. Thanks to the integrated automatic switch-on (auto-on/off) and a new circuit design with very low idle current, the power consumption of the speakers is reduced to a minimum.

Assembly

Use our SB-VESA brackets for direct mounting on displays. These can be used on displays measuring from approximately 40 to 100 inches. Alternatively, you can use our WH 80 brackets to attach the speakers directly to the wall or to a wall panel for flush mounting (brackets must be ordered separately).

Key Features

- Active stereo soundbar with DSP
- Very linear frequency range
- Optimized speech intelligibility
- Control via LB CONTROL App and Network commands
- Analog and digital inputs
- Optional DANTE interface
- 2 × 50 watts power capacity
- Automatic switch-on
- Switchable Ground-Lift
- Customized versions on measure for display widths from 960 up to 2350 mm
- VESA mounts for display heights up to 100 inches

Fields of Application

- Conference rooms
- Stand-alone solutions
- Presentations
- Exhibitions, trade fairs
- Sales rooms
- Gastronomy



Connection terminal
SB-A 2.0 DCS

SB-A 2.0 DSC / SB-A 2.0 DSC DANTE

Active Stereo Soundbar with Integrated DSP

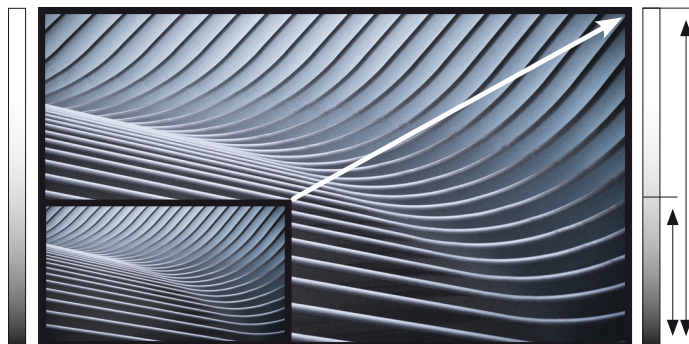

Customized versions with height on measure for display height from 700 up to 1600 mm

Technical Data

Principle	Active stereo soundbar with class-D amplifiers and DSP.
Components	2 × 2.5" full-range drivers + 2 × 2.5" woofers + 4 × 2.5" passive radiators
Frequency range	55 Hz – 20 kHz
Power capacity	2 × 50 watts
Maximum SPL	max. 109 dB (1 W/1m)
Nominal dispersion	120°
Connectors	Line In Stereo, symmetrical and Cinch, optical SPDIF input (Toslink), RJ45 Ethernet socket, pluggable system terminals for passive speaker and external power supply, mini jack input cable 3.5mm to Cinch, 1.5 m. The model SB-A 2.0 DSC DANTE also has an Ethernet socket for DANTE
Dante®	
Input sensitivity	0 dBu for full modulation, Impedance 4.7 kohms
Operating controls (back)	LED Standby/Sleep/On/Limit, Ground-Lift Switch
Automatic switch-on	Switch-off with approx. 10 min. delay
Power supply	Extern power supply 24 VDC
Mains connection	90 – 240 VAC
Dimensions (W × H × D)	960 × 80 × 48 mm
Weight	4,5 kg
Cabinet	Aluminium, front precisions steel grille, powder-coated, black
Suspension points	Threaded inserts 4 × M 6 at rear
Warranty	5 years

Model	Order-No.	Version
SB-A 2.0 DSC	1213-0007	Standard version, 960 mm width, black
SB-A 2.0 DSC DANTE	1213-0012	Standard version, 960 mm width, black
Customized version with width on measure		
SB-A 2.0 DSC-1200	1213-0008	Width on measure from 960 – 1200 mm, black
SB-A 2.0 DSC-1200 DANTE	1213-0013	Width on measure from 960 – 1200 mm, black
SB-A 2.0 DSC-1600	1213-0009	Width on measure from 1200 – 1600 mm, black
SB-A 2.0 DSC-1600 DANTE	1213-0014	Width on measure from 1200 – 1600 mm, black
SB-A 2.0 DSC-2000	1213-0010	Width on measure from 1600 – 2000 mm, black
SB-A 2.0 DSC-2000 DANTE	1213-0015	Width on measure from 1600 – 2000 mm, black
SB-A 2.0 DSC-2350	1213-0011	Width on measure from 2000 – 2350 mm, black
SB-A 2.0 DSC-2350 DANTE	1213-0016	Width on measure from 2000 – 2350 mm, black
Fee SB	1213-0006	Customized version fee SB (one-time charge per display type and order)

Accessories	Order-No.	Version
VESA-Mounts		
SB-VESA	7111-0012	VESA mount for displays from 40" – 100"
Wall-mounts for wall assembly		
WH 80	7111-0013	Adjustable to a distance of 35 to 110 mm from the wall, pair

SB-A 2.0 DSC / SB-A 2.0 DSC DANTE

Active Stereo Soundbar with Integrated DSP

Dimensions

Customized versions on measure for display widths from 960 up to 2350 mm

SB-A 2.0 DSC Standard

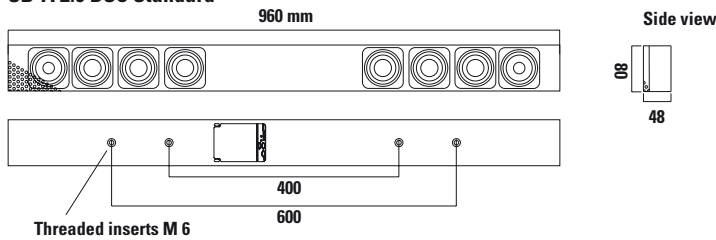

Power Supply

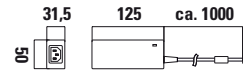

SB-A 2.0 DSC-1200

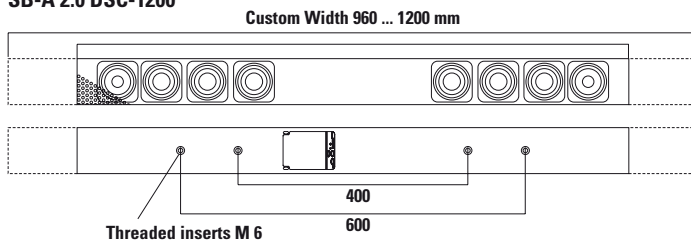

SB-A 2.0 DSC-1600

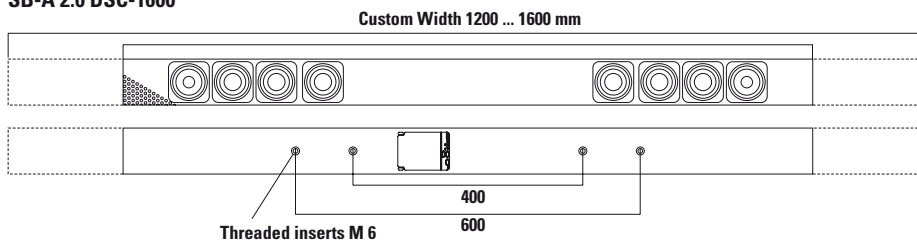

SB-A 2.0 DSC-2000

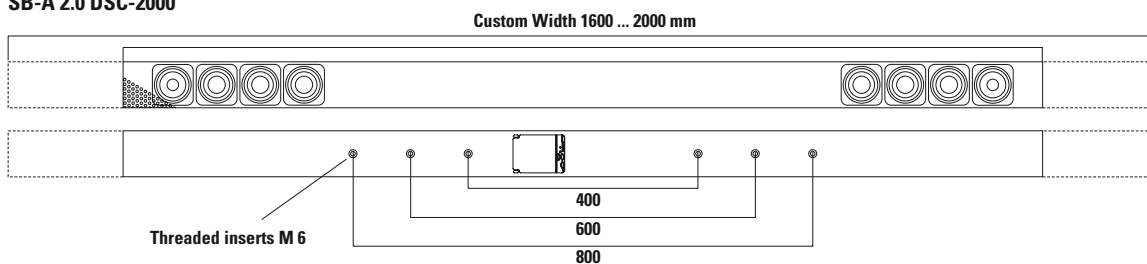

SB-A 2.0 DSC-2350

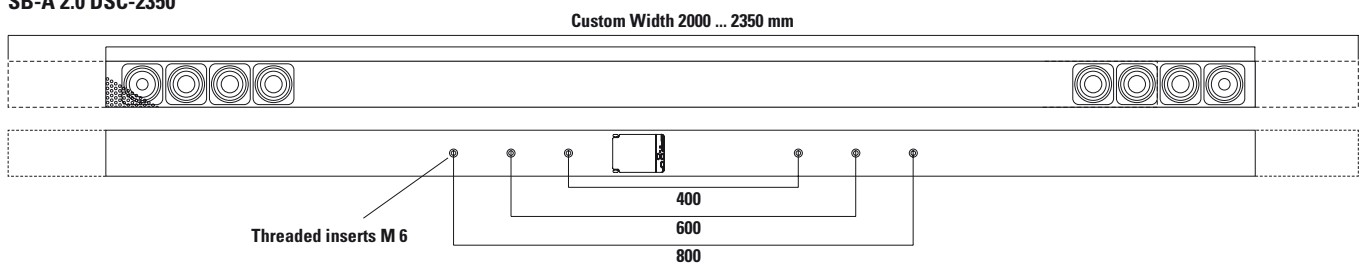

SB-A 2.0 DSC / SB-A 2.0 DSC DANTE

Active Stereo Soundbar with Integrated DSP

Connection

Backside



Connection terminal
SB-A 2.0 DSC

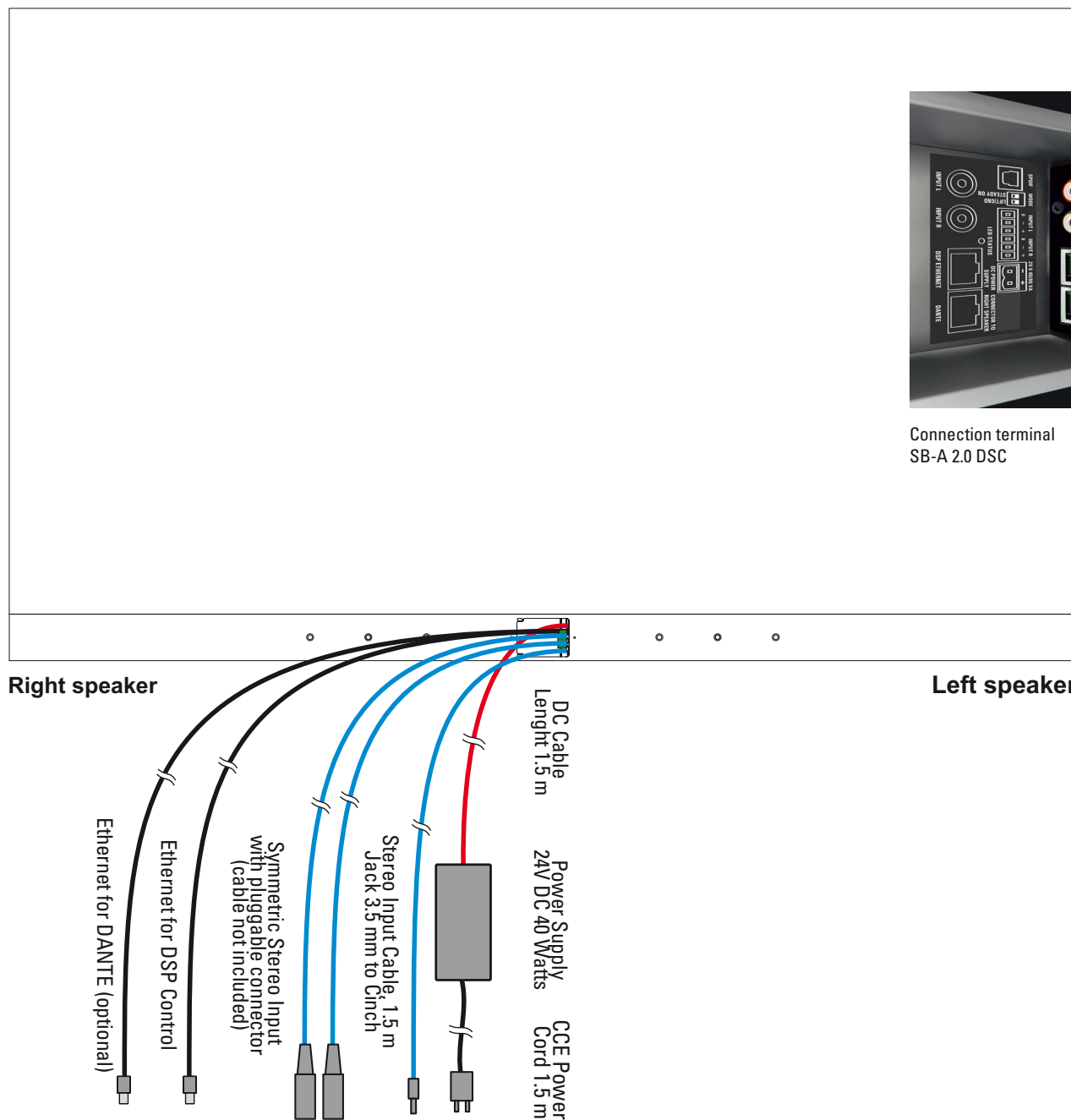

SB-A 2.0 DSC / SB-A 2.0 DSC DANTE

Active Stereo Soundbar with Integrated DSP

Dimensions: VESA Mounts

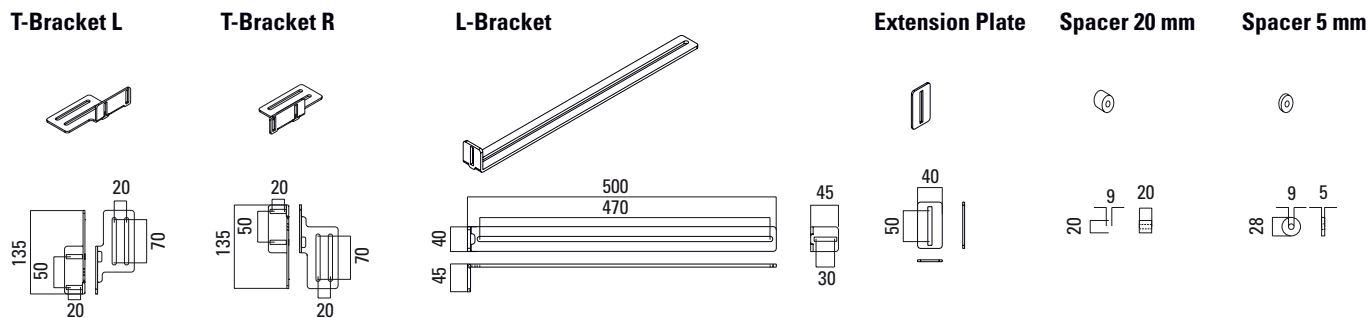

Mounting

Mounting with SB-VESA to a 85" Display with VESA 600 x 400 Points

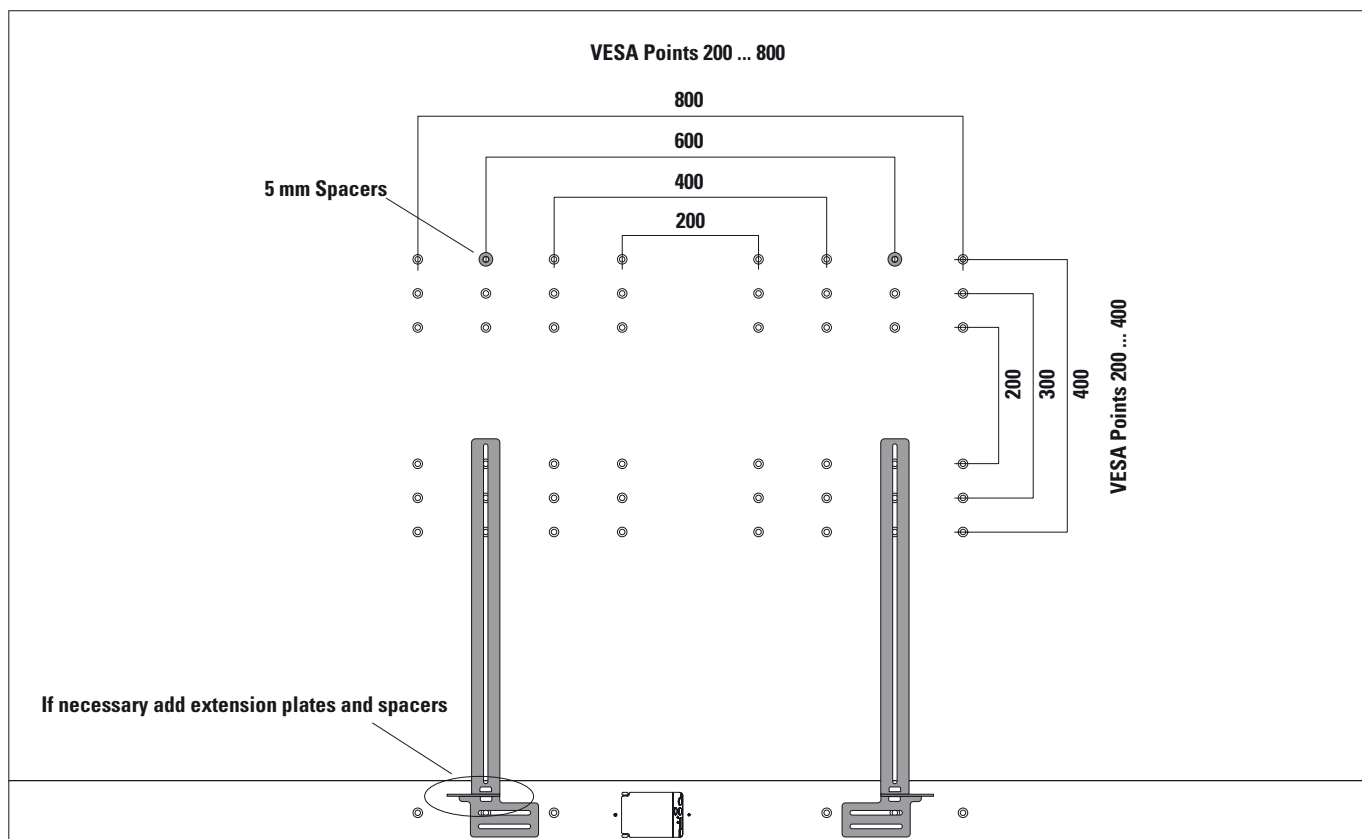

SB-A 2.0 DSC / SB-A 2.0 DSC DANTE Active Stereo Soundbar with Integrated DSP

LB CONTROL App

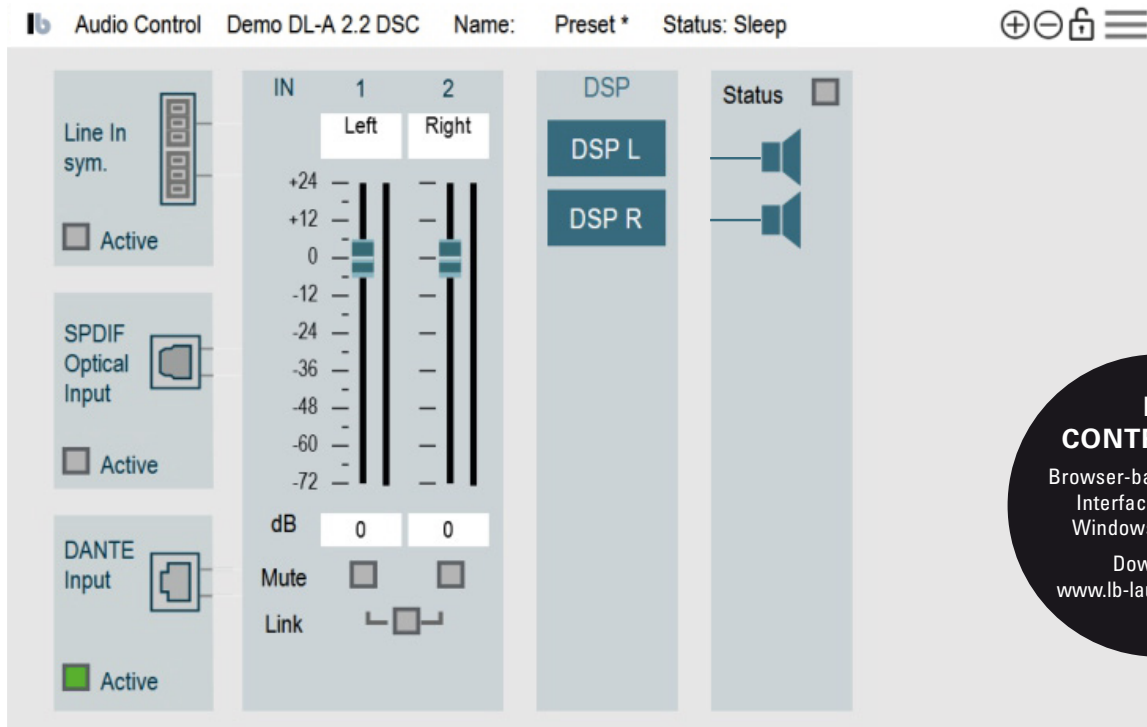

The SB-A 2.0 DSC are configured with our browser-based **LB CONTROL App**. Network settings, lock functions, presets and audio settings (parametric EQs, delays, compressor and limiter) can be edited here. (Download on our website)

The SB-A 2.0 DSC can be controlled and monitored via network commands. You can find the list of network commands in the operating instructions for our LB CONTROL App.



LB CONTROL App
Download Software