























Unpacking

Before using the device, check the device model and ensure that the shipped box includes the following items:

 1 x R25A	 1 x Wiring cover	 6 x M2.5x6 crosshead screw	 1 x Rope	 1 x Sealing pressing plate
 4 x Wall-mounting screw	 2 x Diode	 4 x Plastic wall anchor	 1 x Allen wrench	 4 x ST4x20 crosshead screw
 2 x M3x6 hex socket screw	 1 x Wall-mounting bracket	 2 x M4x30 crosshead screw	 1 x Rubber plug (small)	 1 x Rubber plug (medium)
 1 x Rubber plug (large)				

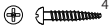
Flush-mounting Accessories:

 1 x Flush-mounting bracket	 1 x Flush-mounting box	 4 x M3x6 crosshead screw	 2 x M4x15 torx screw	 4 x ST4x20 crosshead screw
 1 x Torx wrench	 4 x Plastic wall anchor			

Product Overview

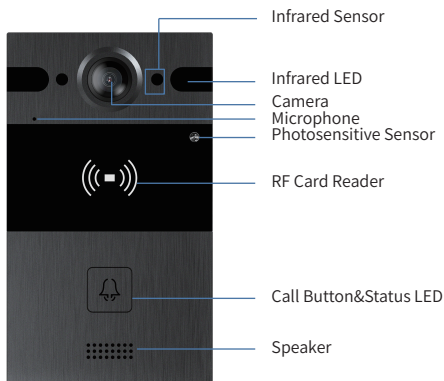

R25A

Before You Start

Tools needed

(not included in shipped box)

- Cat Ethernet Cable
- Crosshead Screwdriver
- Electric Drill

Voltage and Current Specifications

- It is suggested that use PoE or 12VDC 1A power adapter to power on device.

AWG Sizes and Properties Table

Please follow the property wire date to install device:

Power Supply	12VDC 1A		
AWG	20	22	24
Resistance (ohm/km)	33.9	48.5	79.6
Cross-sectional Area (mm ²)	0.5189	0.3247	0.2047
Wire Length (m)	≤50	≤40	≤20

Requirements

1. Place the device away from sunlight and light sources to prevent potential damage.
2. Do not place the device in the high-temperature, and humid environments or in surroundings impacted by magnetic field.
3. Install the device on the flat surface securely to avoid personal injuries and property loss caused by device's falling.
4. Do not use or place the device near heating objects.
5. If installing the device indoors, please keep device at least 2 meters away from light, and at least 3 meters away from window and door.

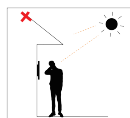

Backlight

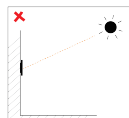

Direct sunlight

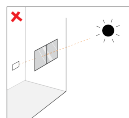

Direct sun
through window



Indirect sunlight
through window

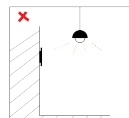

Close to light

Warning!

1. To ensure safety, avoid touching power cord, power adapter, and device with wet hands, bending or pulling the power cord, damaging any components, and use only qualified power adapter and power cord.
2. Be careful that standing up on the area under the device in case of personal injuries cause by hitting the device.

⚠ Caution

1. Do not knock device with hard objects.
2. Do not press down hard on the device screen.
3. Do not expose device to chemical products, such as alcohol, acid liquid, disinfectants, and so on.
4. To prevent the device installation from becoming loose, ensure accurate diameters and depths of screw holes. If the screw holes are too large, use glue to secure the screws.
5. Use wet cloth clean device surface softly, and then wipe the surface with dry cloth for cleaning the device.
6. If there is abnormal situation of the device, including uncommon sound and smell, please power off the device and contact Akuvox Technical Team immediately.

Device Wiring

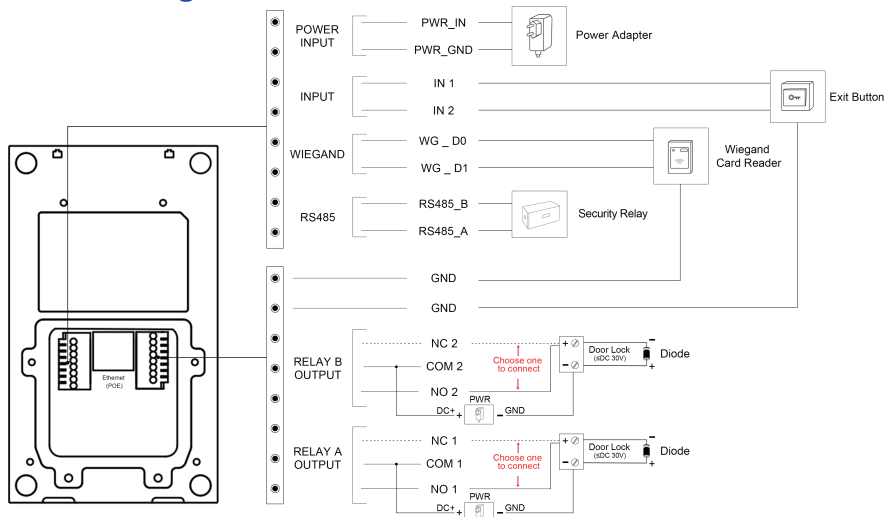

⚠ Warning!

When you connect a device containing a coil, such as a relay or an electromagnetic lock, it is necessary to protect the intercom against voltage peak while switching off the induction load. For this way of protection we recommend a diode 1A/200V (included in the accessories) connected antiparallel to the device.

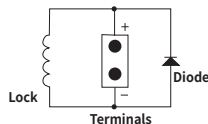

Installation

Step1: Flush-mounting Box Installation

1.1 Normal Installation

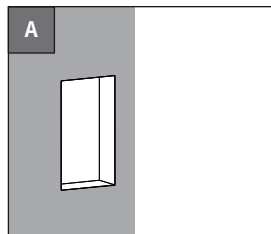

Cut out a square hole on the wall with the dimension 180*101*50mm (height*width*depth).

Note: Make sure that the cables within the hole or reserve a cable tube.

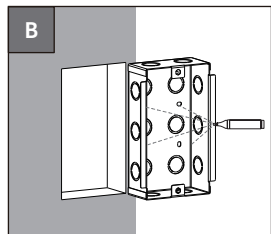

- Insert the **flush-mounting box** into the hole, lead the wires to through the cable holes.
- Mark four screw holes on the wall.

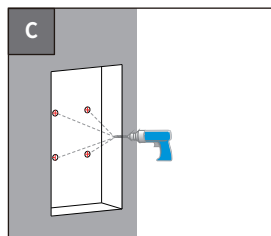

- Insert the **flush-mounting box** into the hole, lead the wires to through the cable holes.
- Mark four screw holes on the wall.

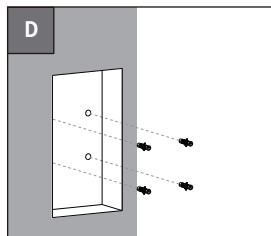

Insert four **plastic wall anchors** into the screw hole.

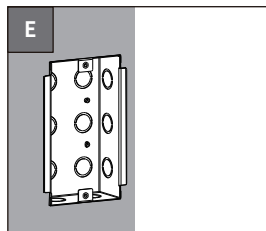

Place the **flush-mounting box** into the square hole, ensuring that the edges are closely against the wall and all wires go through the cable hole.

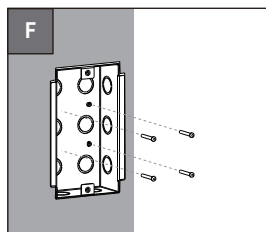

- Tighten the four **ST4x20 crosshead screws** to the **plastic wall anchors** to fasten the **flush-mounting box**.
- Use cement or non-corrosive adhesive to fill the gap between the wall and the box.

1.2 Simple Installation (with lower resistance of vandalism)

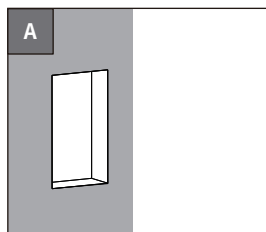

Cut out a square hole on the wall with the dimension 180*101*50mm (height*width*depth).

Note: Make sure that the cables within the hole or reserve a cable tube.

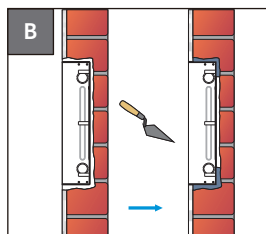

- Use cement or non-corrosive adhesive to fill the gap between the wall and the flush-mounting box.
- Wait for the cement to dry before proceeding to the next step.

Note: To prevent water from entering the back cover of the door phone, it is recommended to fill the gaps around with waterproof material.

Step2:Main Unit Installation

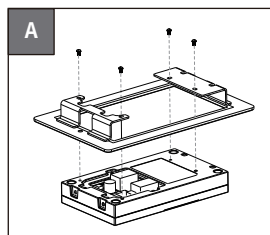

Use four **M3x6 crosshead screws** to fix **R25A** on the flush-mounting bracket.

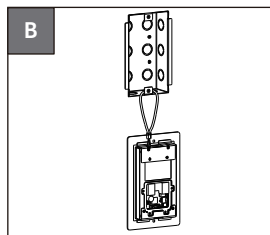

Hang **R25A** on the **flush-mounting box** with rope for easier installation.

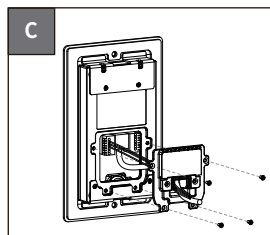

a. Make wires go through the **wiring cover** and connect them to the corresponding interfaces of the main board.
b. Fasten the **wiring cover** with four **M2.5x6 crosshead screws**.

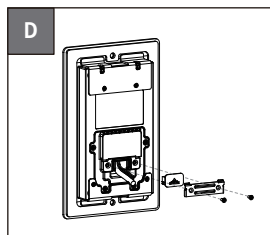

a. Select a suitable **rubber plug** to secure the wires.
b. Fix **sealing pressing plate** to the **wiring cover** with two **M2.5x6 crosshead screws**.

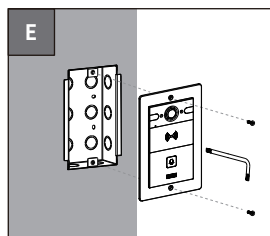

a. Place the device into the **flush-mounting box**.
b. Use **Torx wrench** to tighten the device with two **M4x15 Torx head screws**.

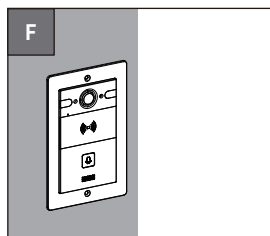

After successful installation, check the stability of device and remove the protective film.

Application Network Topology

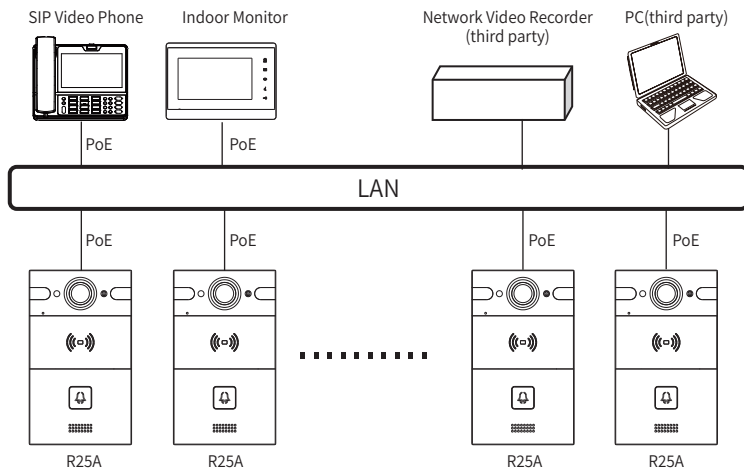

Device Test

LED Status		Description
Blue	Always on	Normal status
	Flashing	Calling
Red	Flashing	Offline
Green	Always on	Talking on a call
	Flashing	Receiving a call

Note: For more LED settings, please refer to R25A web: [Intercom > LED Setting](#).

Device Test

Please verify the device status after installation:

- 1. Network:** Press and hold **Call button** to obtain IP address, network is working properly if the device announce IP address. If no IP address is obtained, E12X will announce "IP 0.0.0.0".
- 2. Intercom:** Press **Call button** to make a call. The call configuration is correct if the call is successful.
- 3. Access Control:** Use pre-configured RF card to unlock door.

Warranty

- Akuvox warranty does not cover intentional mechanical damage or destruction caused by improper installation.
- Do not attempt to modify, alternate, maintain, or repair device by yourself. Akuvox warranty does not apply to damages caused by anyone who is not representative of Akuvox or an Akuvox authorized service provider. Please contact Akuvox Technical Team if the device need to be repaired.

Get Help

For help or more assistance, contact us at:

 <https://ticket.akuvox.com/>

 support@akuvox.com

Scan the QR code to get more videos, guides, and additional product information.



Notice Information

Information contained in this document is believed to be accurate and reliable at the time of printing. This document is subject to change without notice, any update to this document can be viewed on Akuvox' s website: <http://www.akuvox.com> © Copyright 2024 Akuvox Ltd. All rights reserved.