

Unpacking

Before you begin using the device, please check the version you got and ensure that the following items are included in the shipped box:

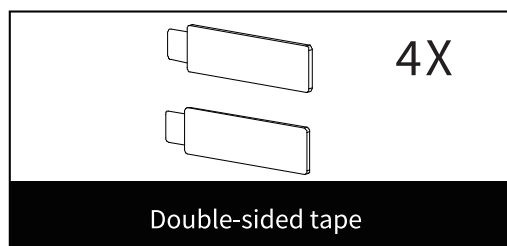

Device Wiring

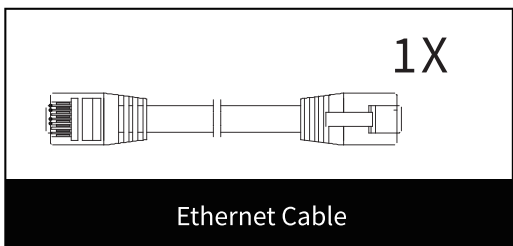
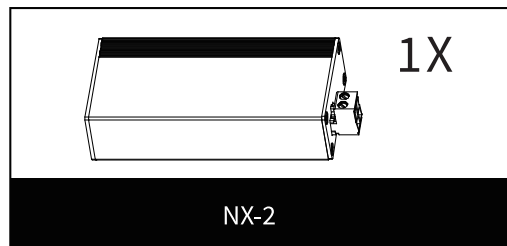
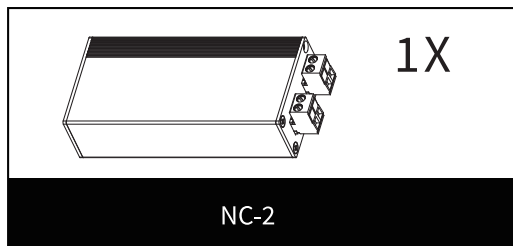
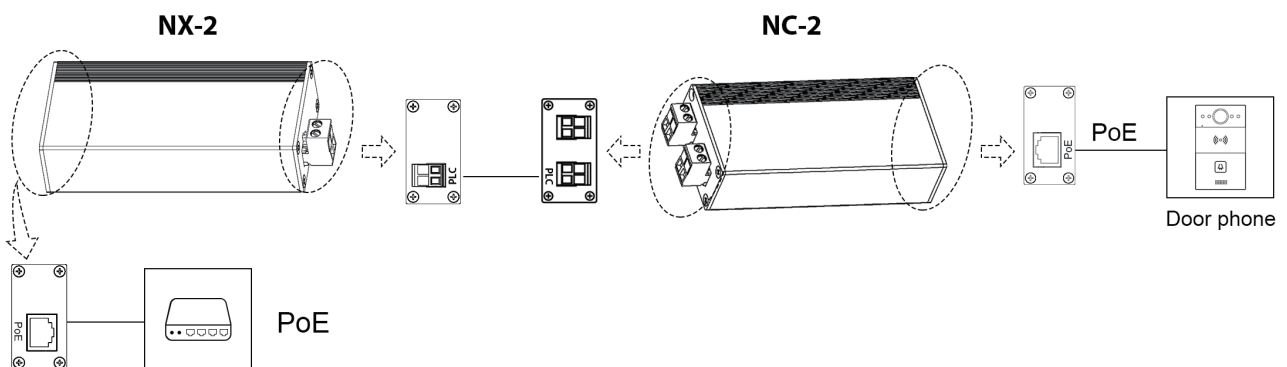

Wire Recommendation

Adapter Voltage	Cable Model	Farthest Distance (The distance between power adapter and door phone)
48V	24awg	50m
	20awg	150m
	18awg	250m

Mode Selection

To ensure normal using, please set NC-2 in **Slave Mode**.

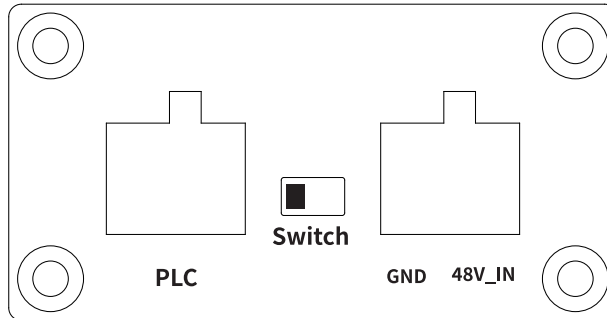

Master mode: Toggle switch to left.

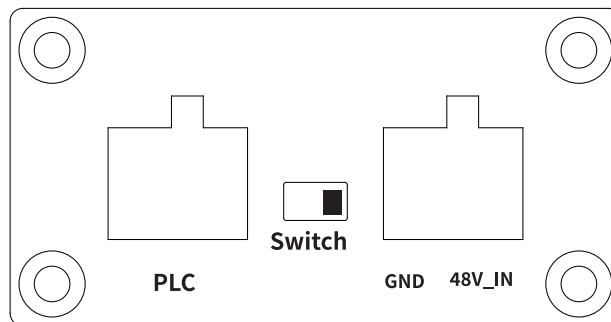

Slave mode: Toggle switch to right.

Device Mounting

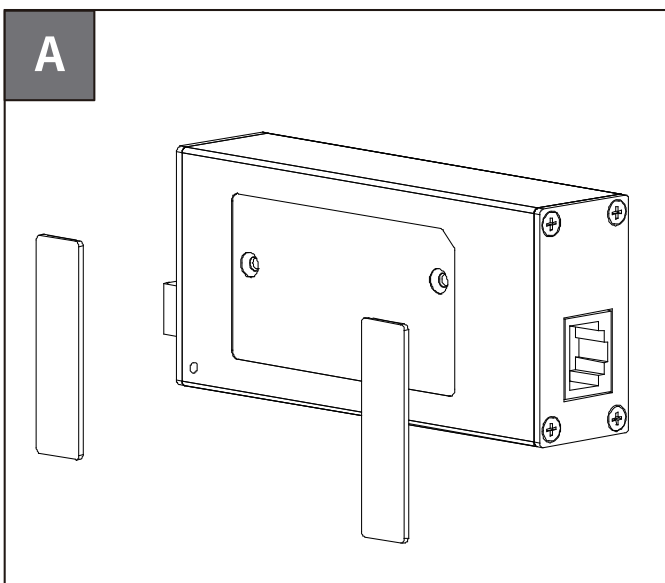

Stick two double-sided tapes on the back of NC-2/NX-2.

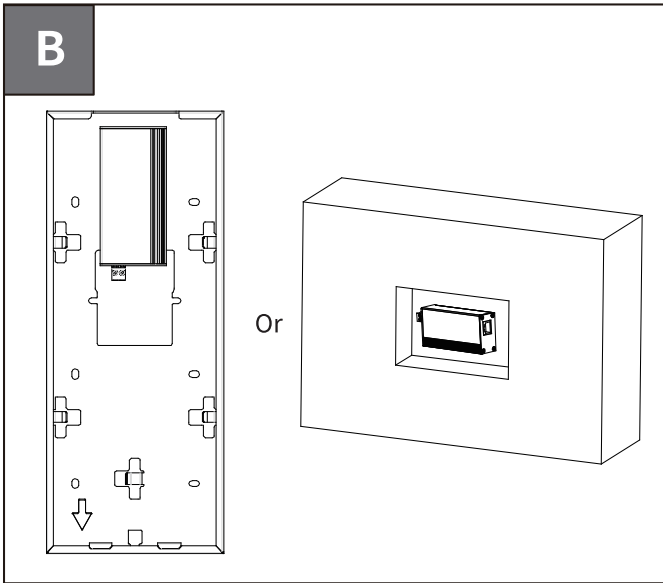

Stick the device onto mounting box of door phone or wall. The installation is done.

Application Network Topology

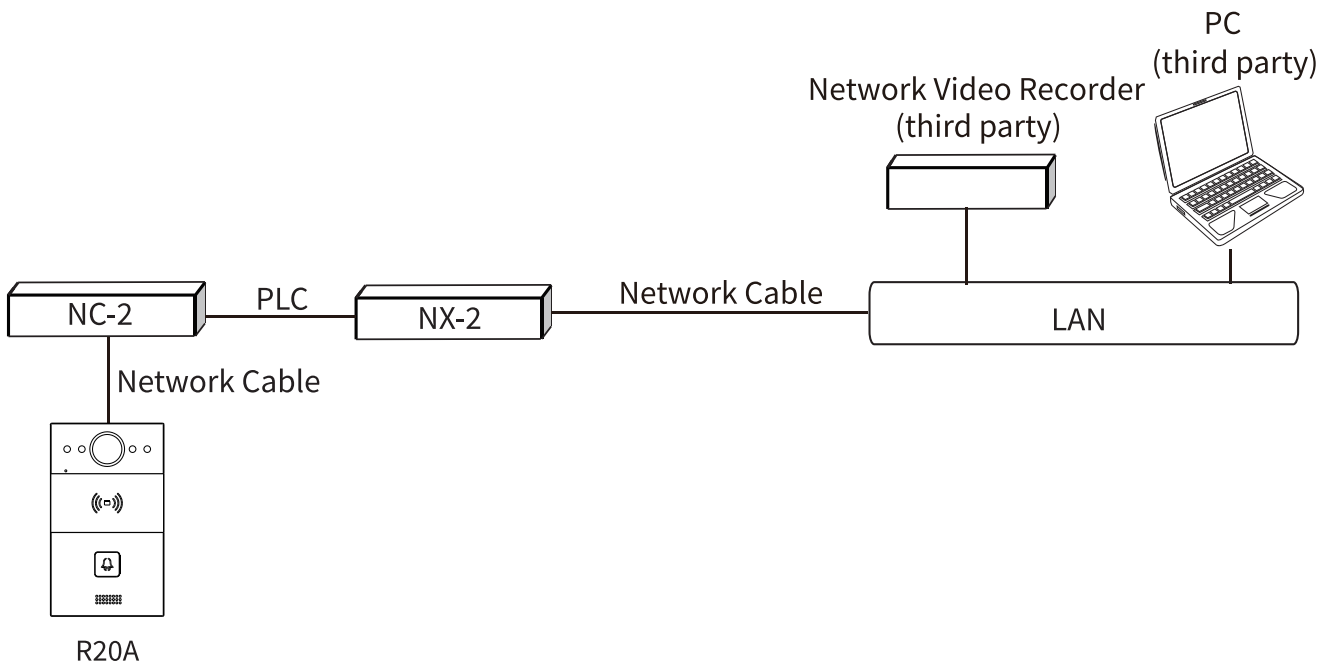

Get Help

For help or more assistance, contact us at:

 <https://ticket.akuvox.com/>

 support@akuvox.com

Scan the QR code to get more videos, guides, and additional product information.



Notice Information

Information contained in this document is believed to be accurate and reliable at the time of printing. This document is subject to change without notice, any update to this document can be viewed on Akuvox's website: <http://www.akuvox.com> © Copyright 2024 Akuvox Ltd. All rights reserved.



YS00000498